

ALPHABET

Colors Worksheets

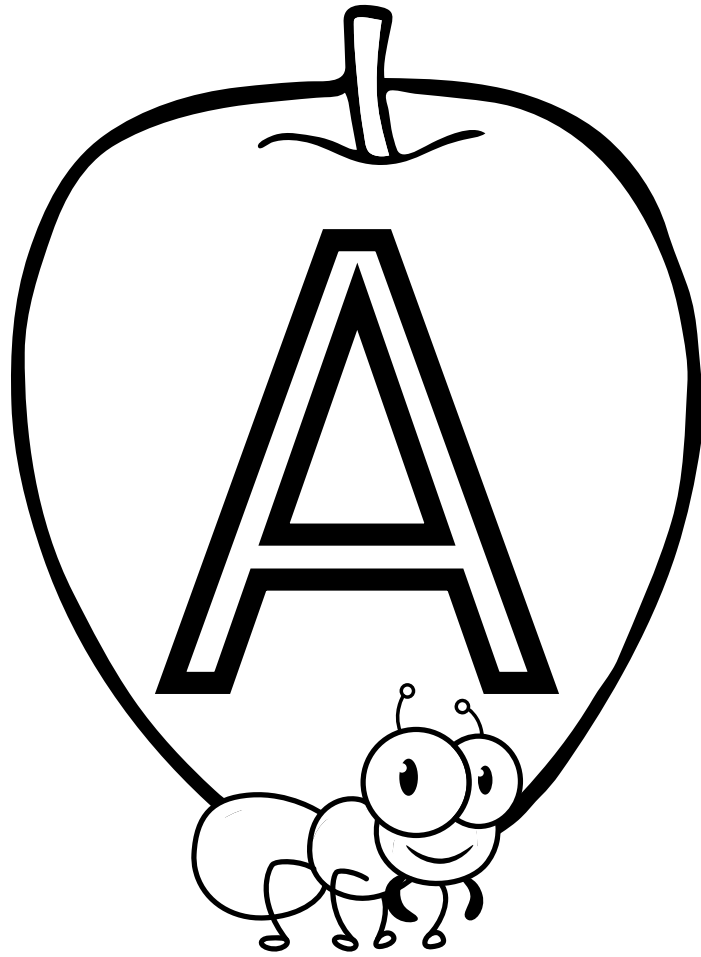



A a A a A a A a

A a A a A a A a

A a A a A a A a

A a A a A a A a

Color Me!

Aa

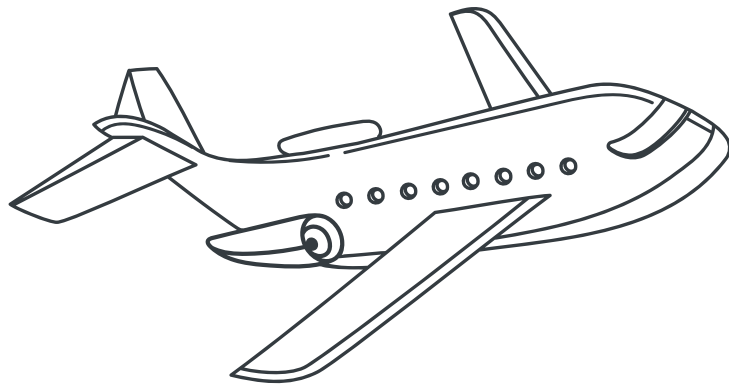

Airplane

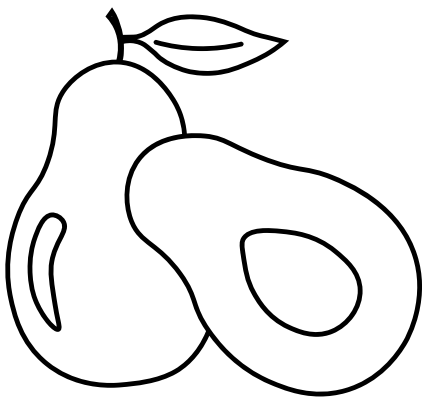

Avocado

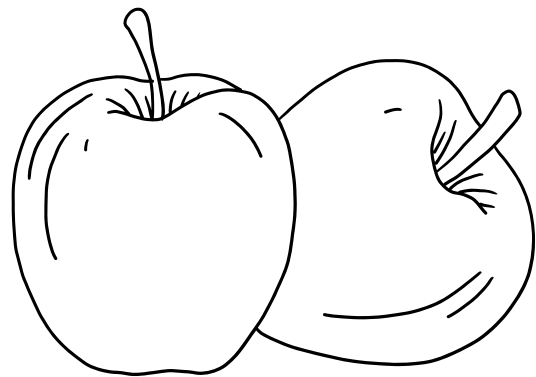

Apple

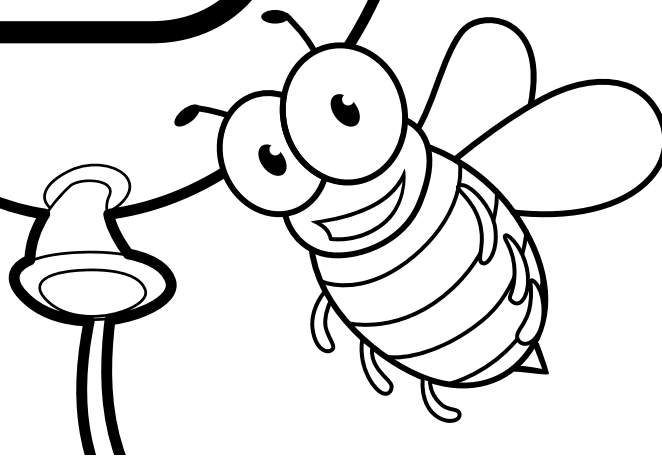
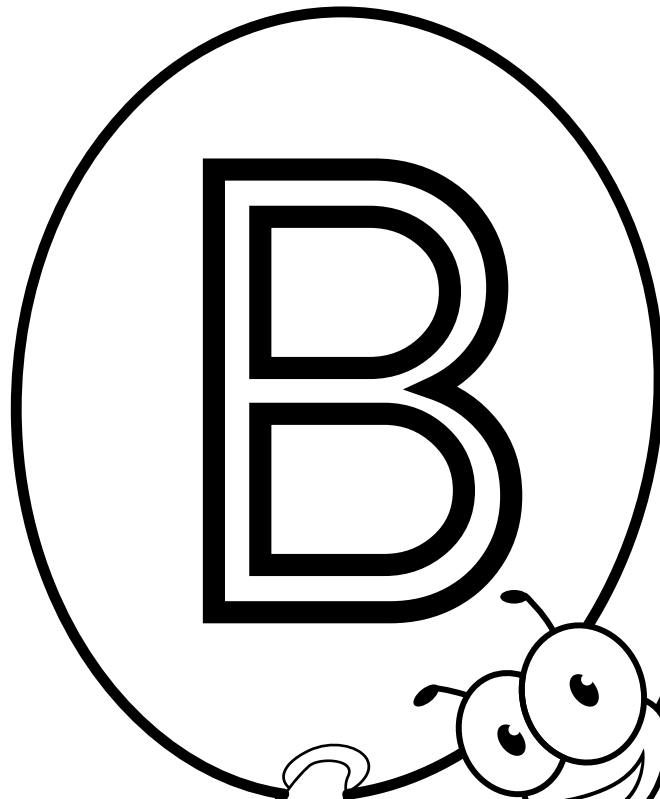

B b B b B b B b

B b B b B b B b

B b B b B b B b

B b B b B b B b

Color Me!

Bb

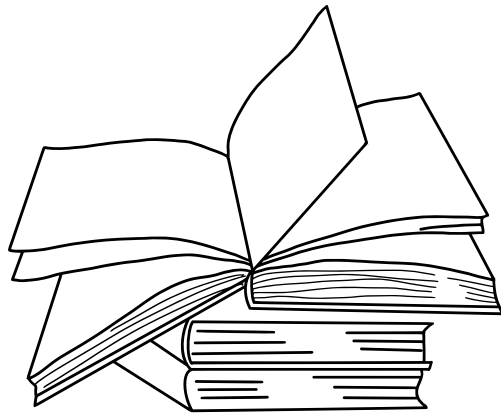

Book



Ball

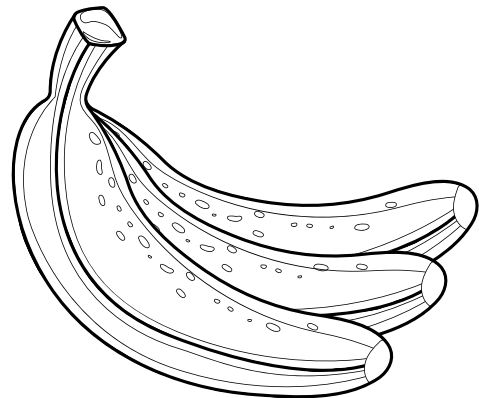

Banana

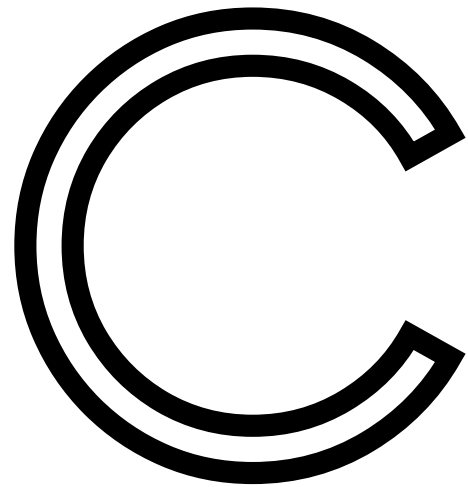
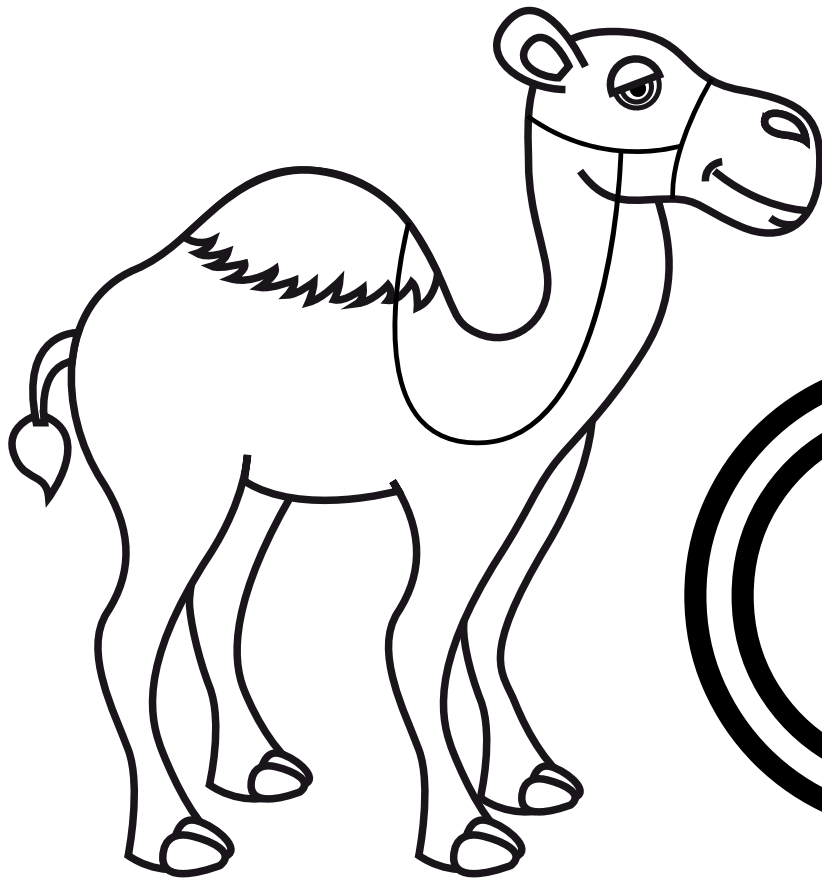

c c C C c c C C c c

c c C C c c C C c c

c c C C c c C C c c

c c C C c c C C c c

Color Me!

Cc

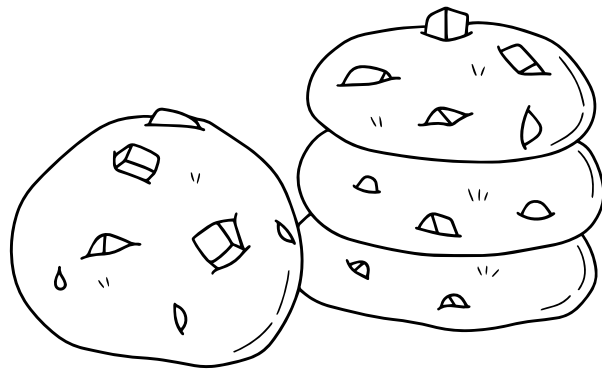

Cookies

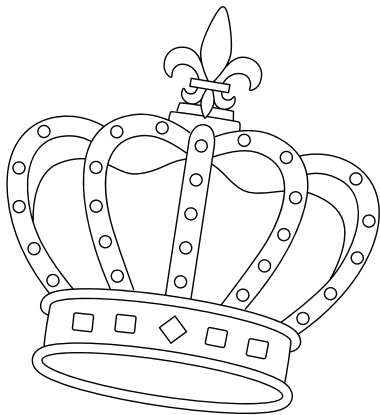

Crown

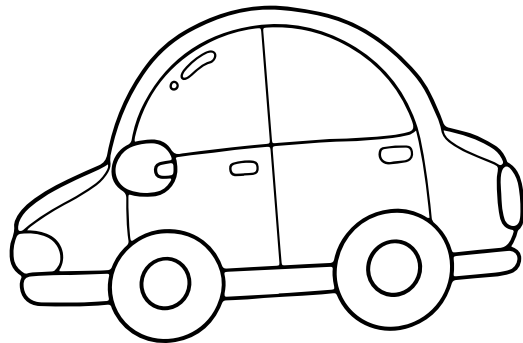

Car

D

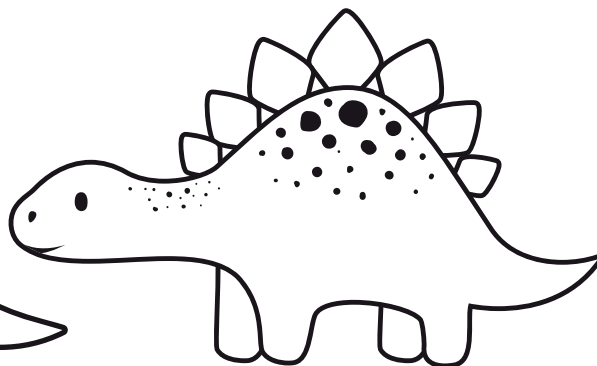
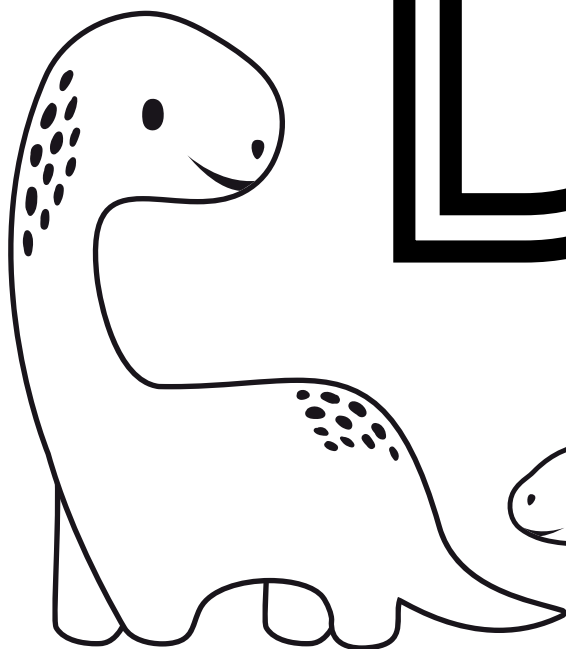

D d D d D d D d D d

D d D d D d D d D d

D d D d D d D d D d

D d D d D d D d D d

Color Me!

Dd

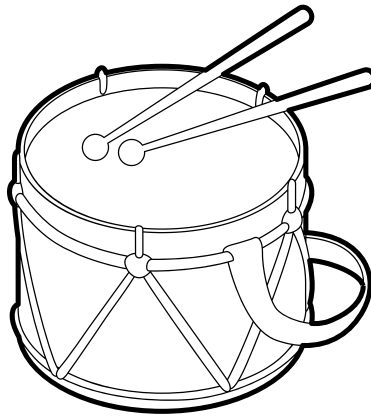

Drum

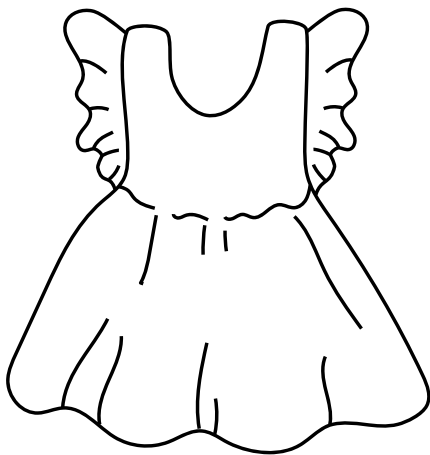

Dress

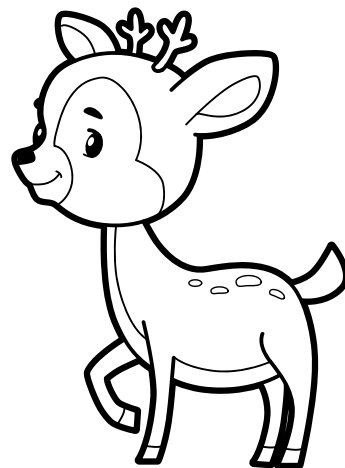

Deer

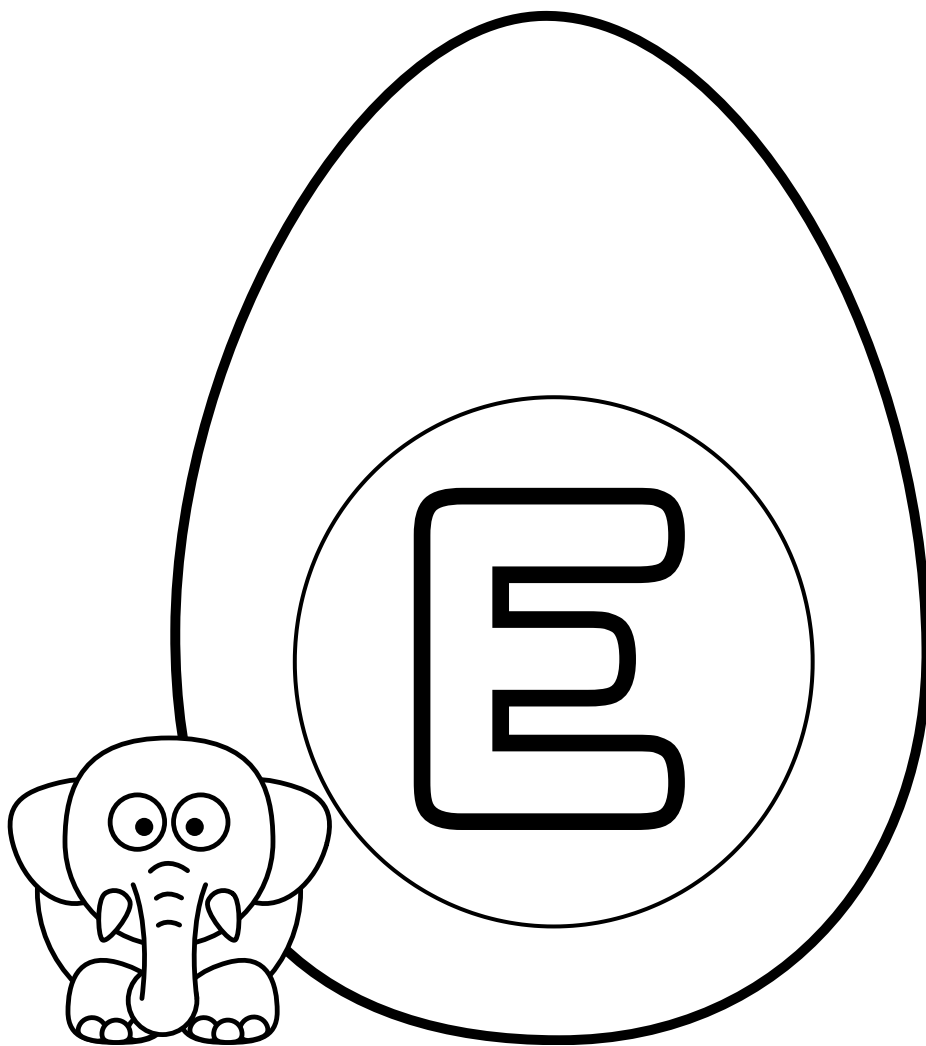

E e E e E e E e E e

E e E e E e E e E e

E e E e E e E e E e

E e E e E e E e E e

Color Me!

Ee

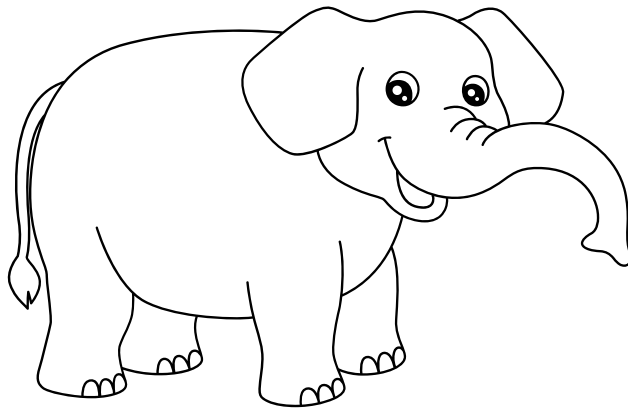

Elephant

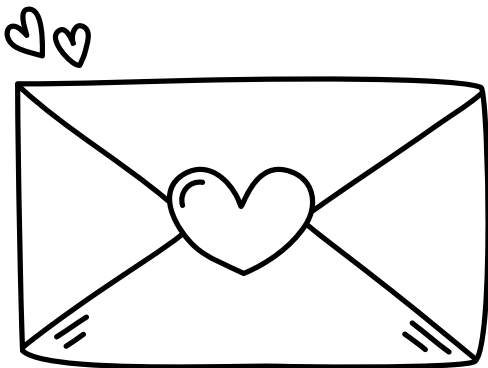

Envelope

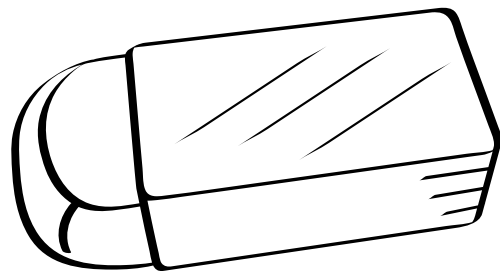

Eraser

F

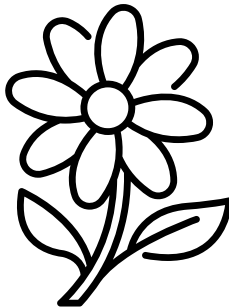
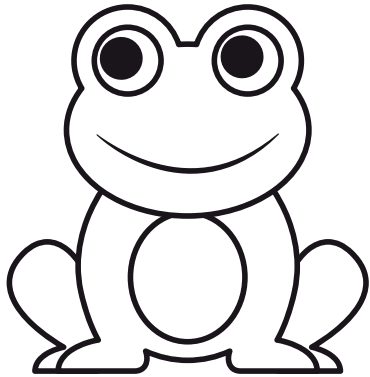

F f F f F f F f F f

F f F f F f F f F f

F f F f F f F f F f

F f F f F f F f F f

Color Me!

Ff

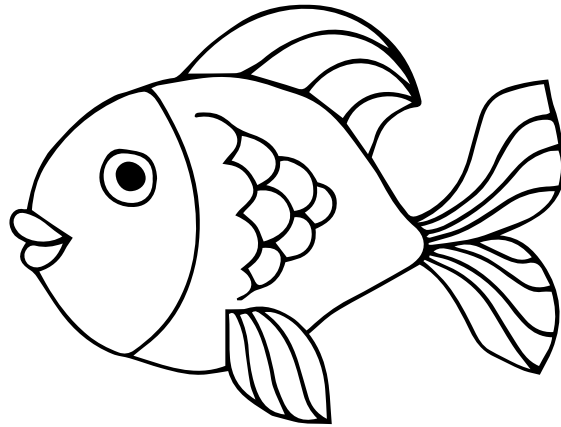

Fish

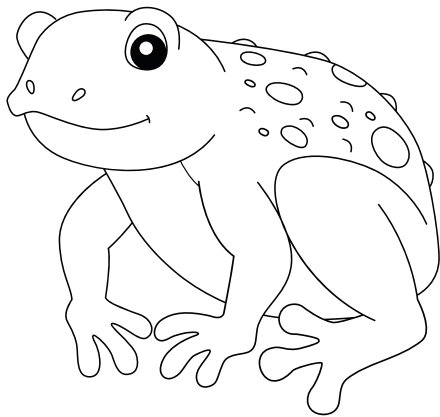

Frog

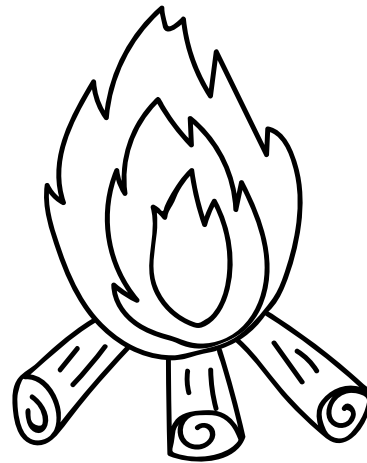

Fire

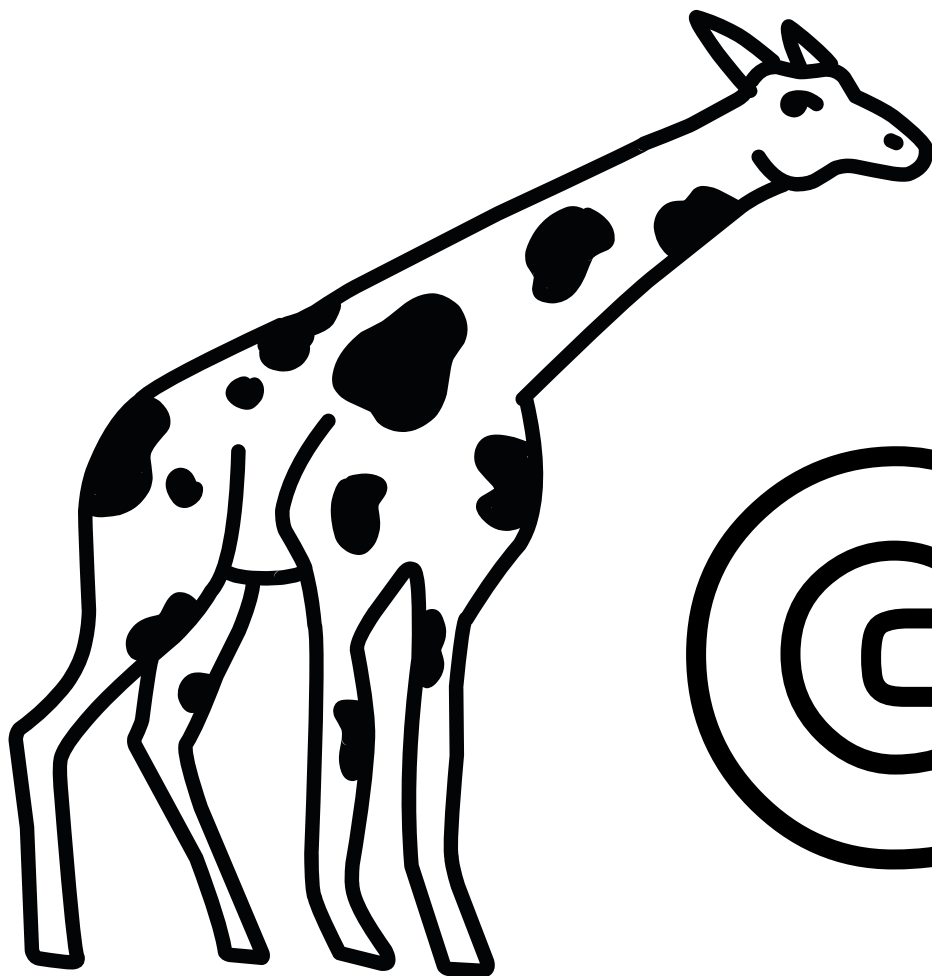

G g G g G g G g G g

G g G g G g G g G g

G g G g G g G g G g

G g G g G g G g G g

Color Me!

Gg



Garlic

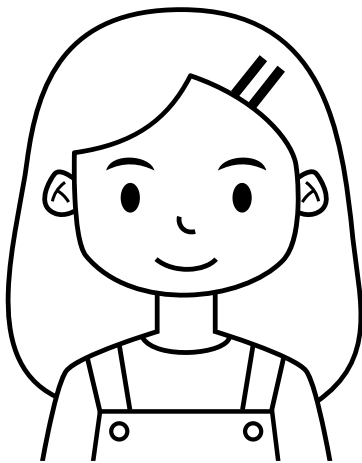

Girl

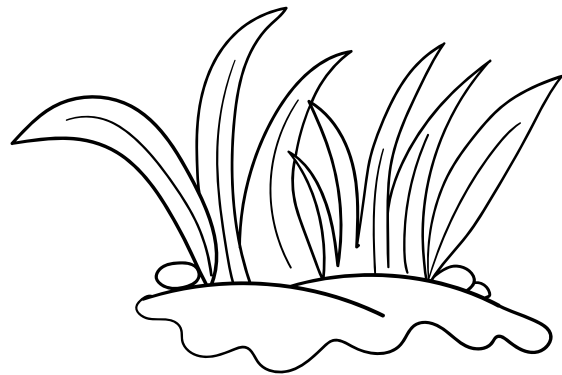

Grass

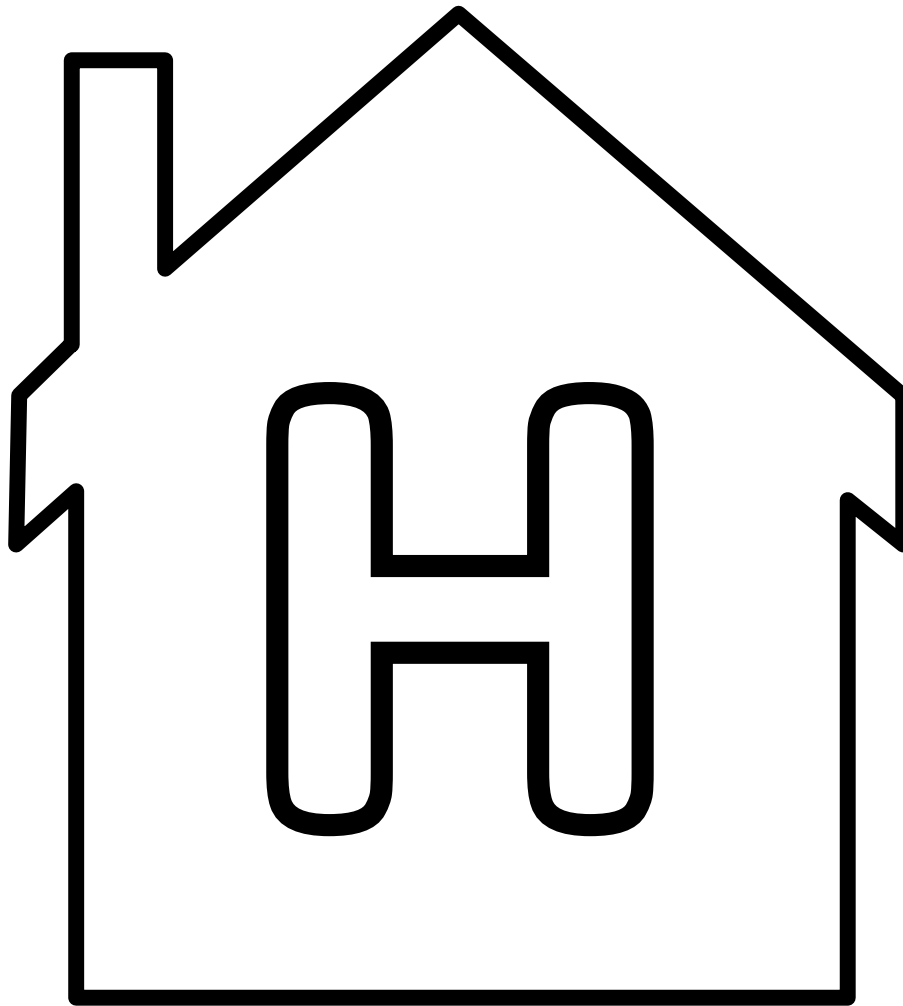

H h H h H h H h H h

H h H h H h H h H h

H h H h H h H h H h

H h H h H h H h H h

Color Me!

Hh

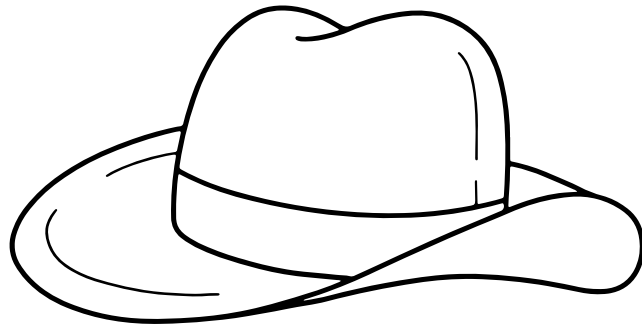

Hat

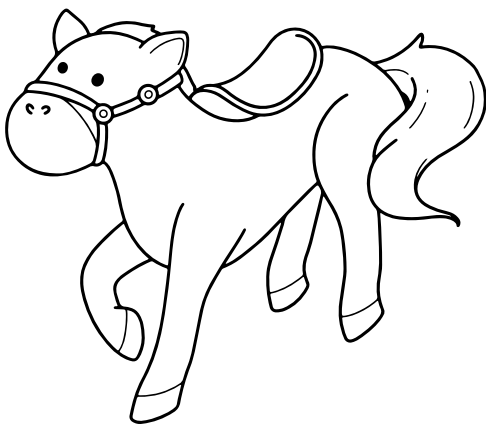

Horse

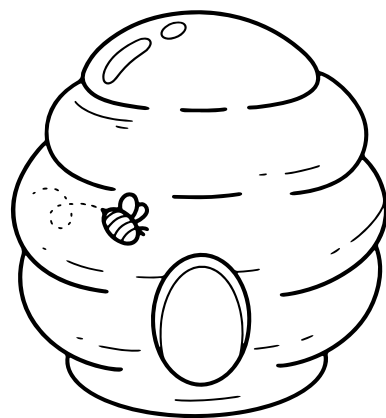

Hive

I

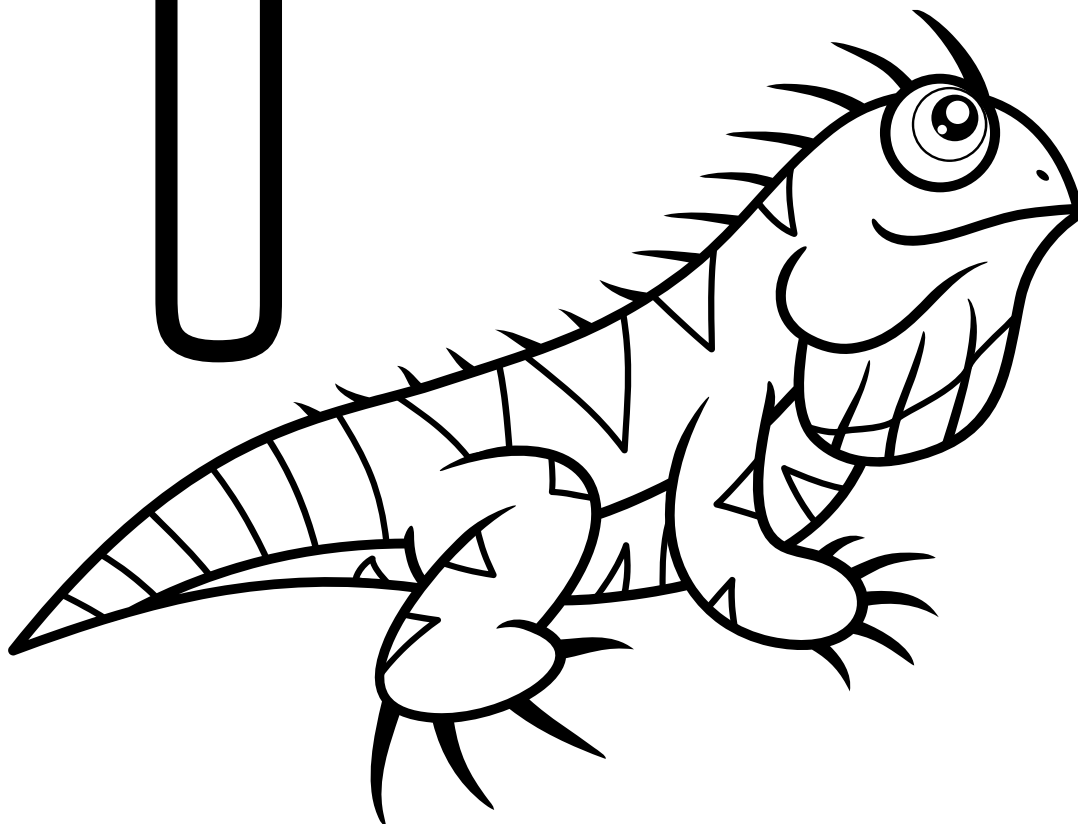

I i I i I i I i I i I i

I i I i I i I i I i I i

I i I i I i I i I i I i

I i I i I i I i I i I i

Color Me!

ii

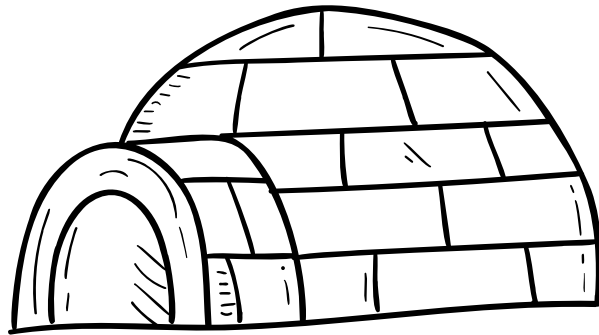

Igloo

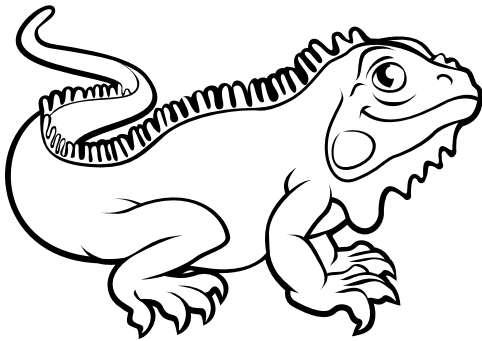

Iguana

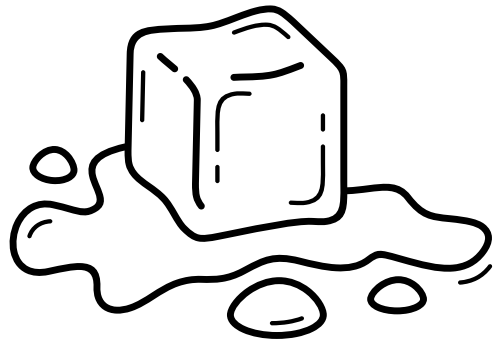

Ice cube

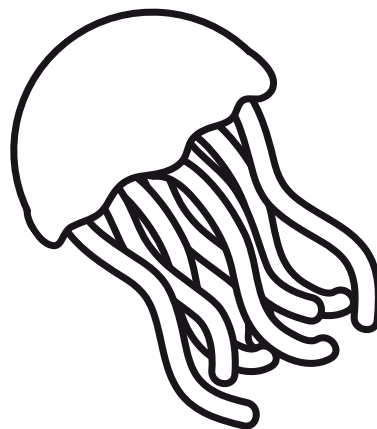
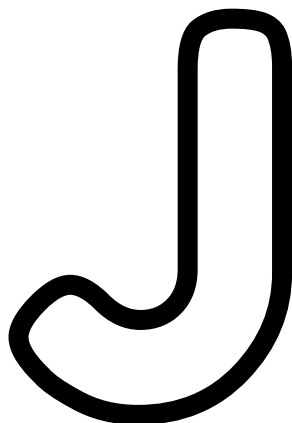
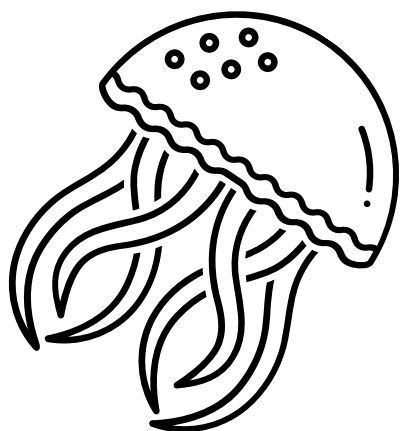

J j J j J j J j J j

J j J j J j J j J j

J j J j J j J j J j

J j J j J j J j J j

Color Me!

Jj

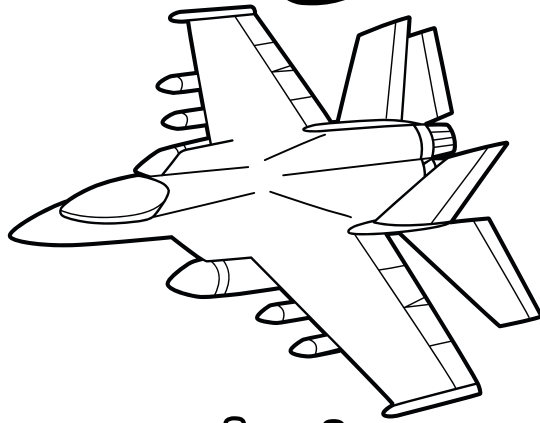

Jet

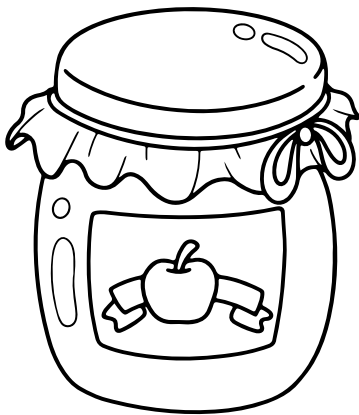

Jam

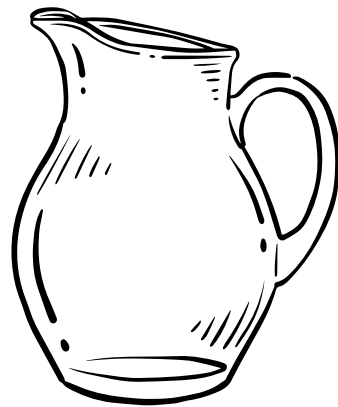

Jug

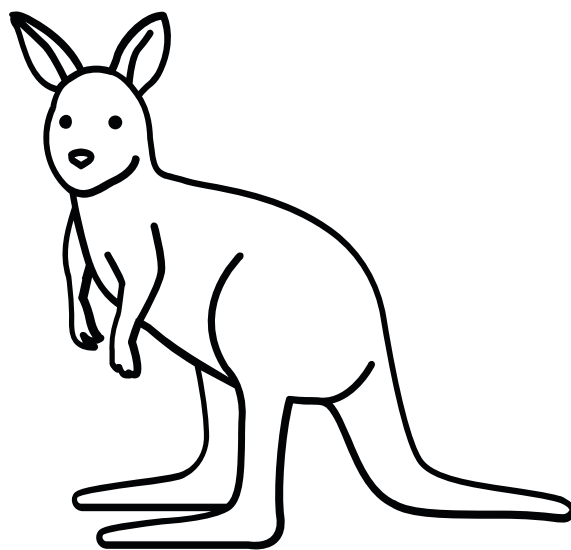
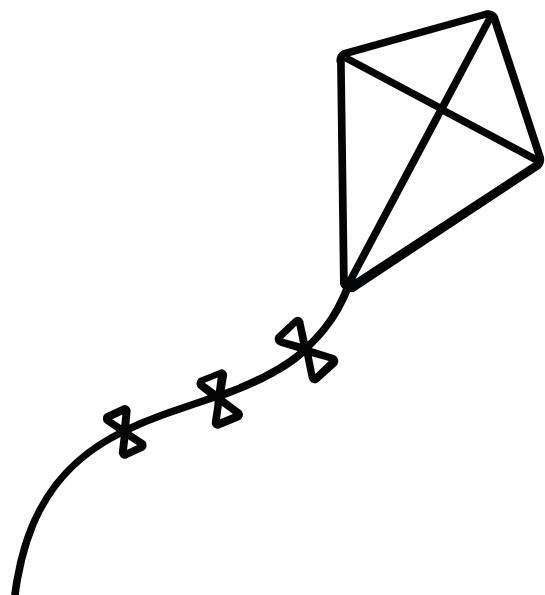

K

K k K k K k K k K k

K k K k K k K k K k

K k K k K k K k K k

K k K k K k K k K k

Color Me!

Kk

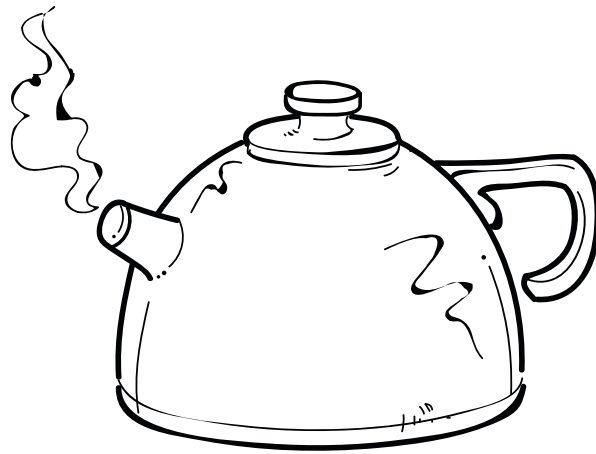

Kettle

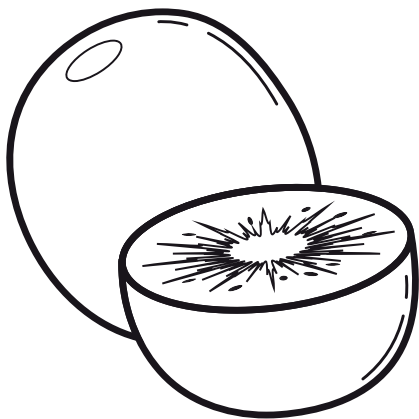

Kiwi

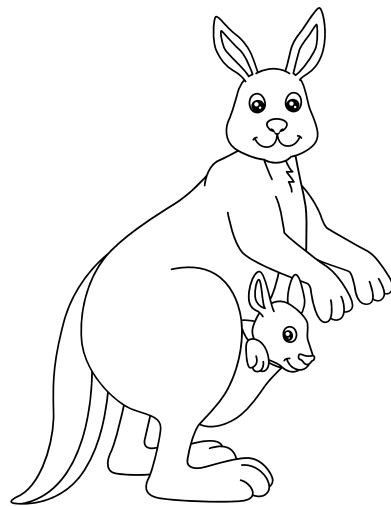

Kangaroo

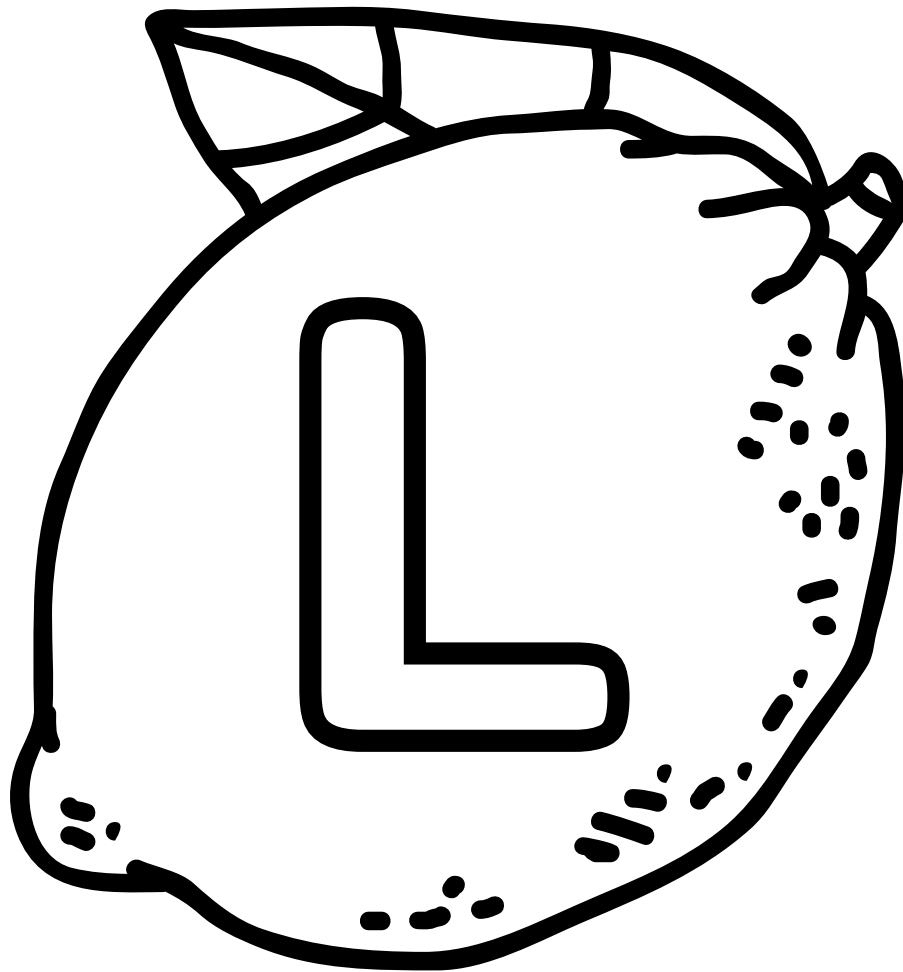

L L

L L

L L

L L

Color Me!

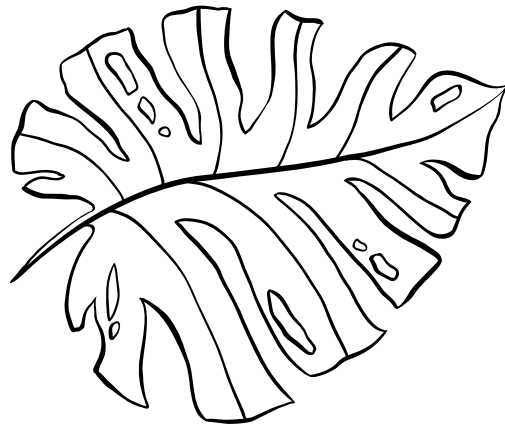
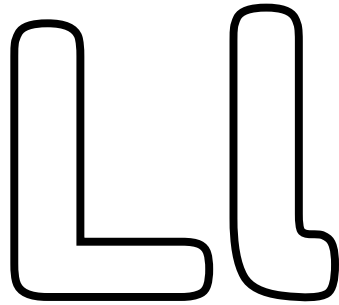

Leaf



Lion

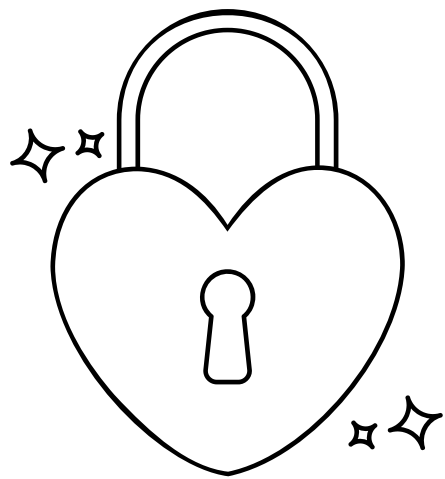

Lock

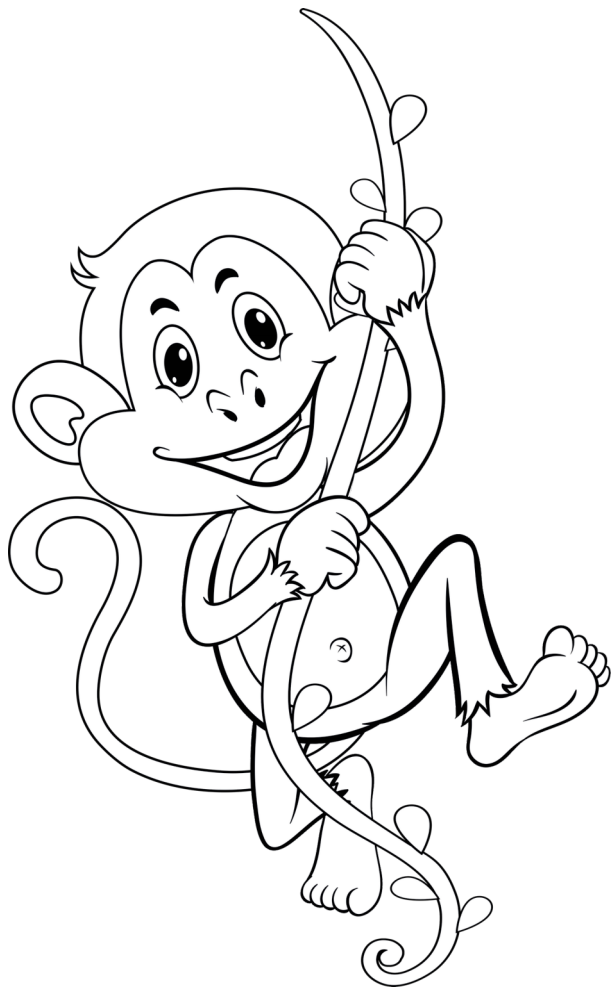

M

M m M m M m M m

M m M m M m M m

M m M m M m M m

M m M m M m M m

Color Me!

Mm

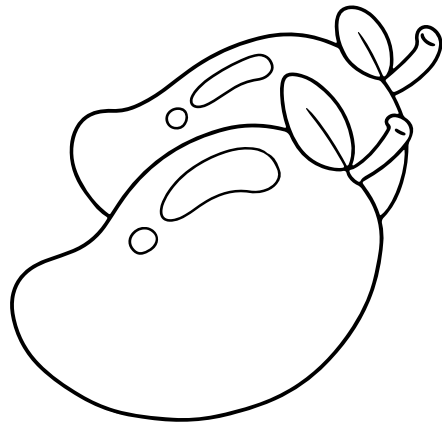

Mango



Mushroom

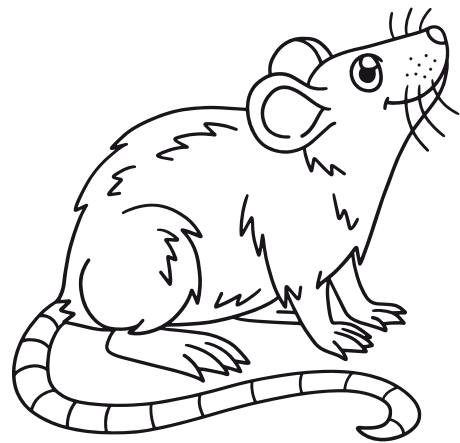

Mouse

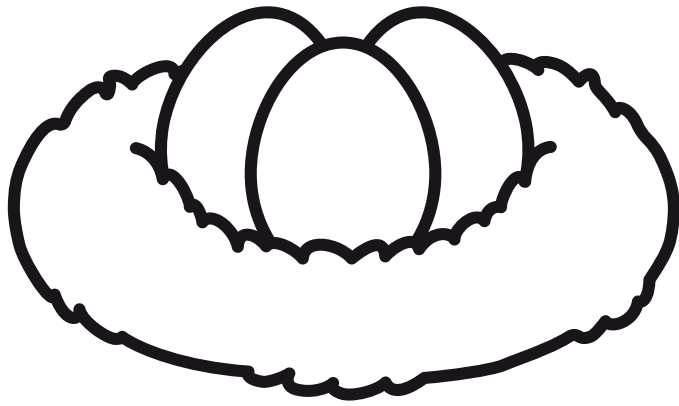

N

N n N n N n N n N n

N n N n N n N n N n

N n N n N n N n N n

N n N n N n N n N n

Color Me!

Nn

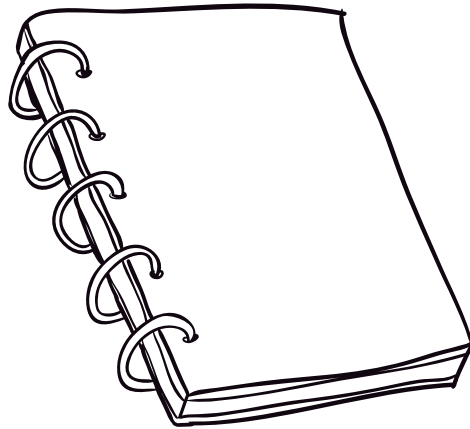

Notebook



Noodles

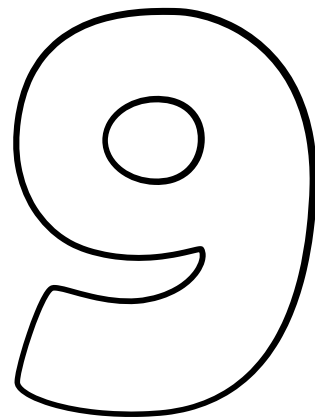

Nine

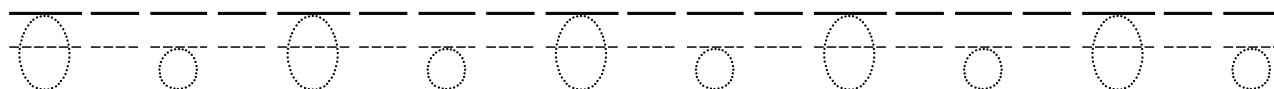
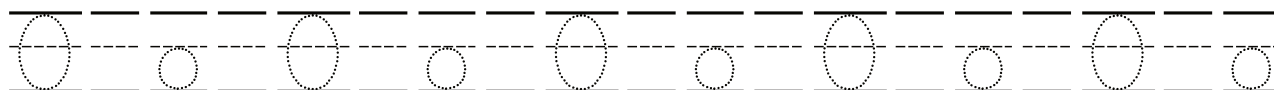
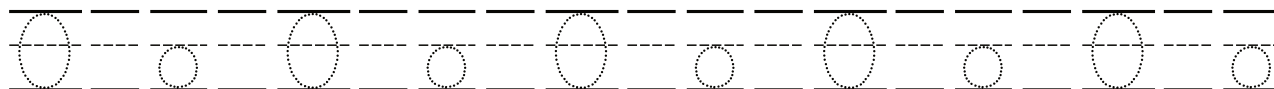
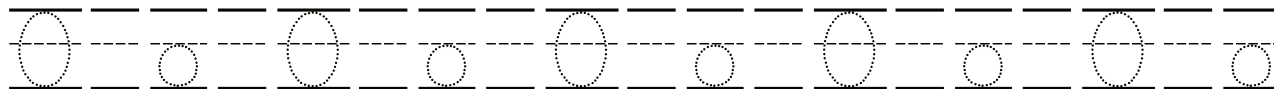
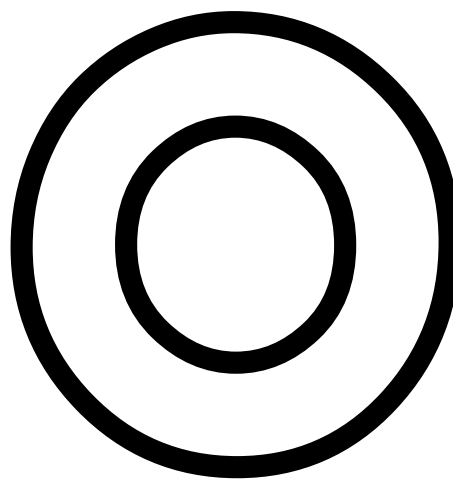
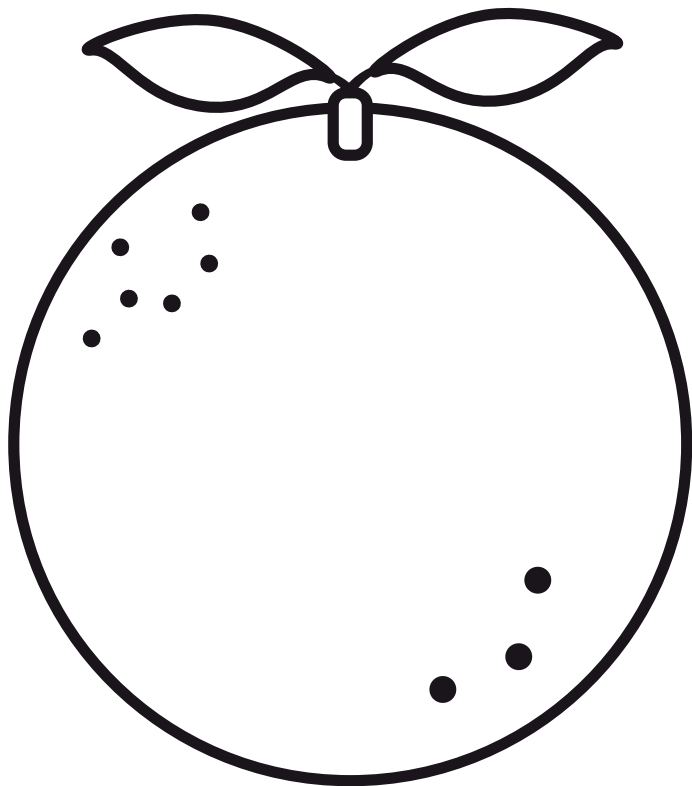

Color Me!

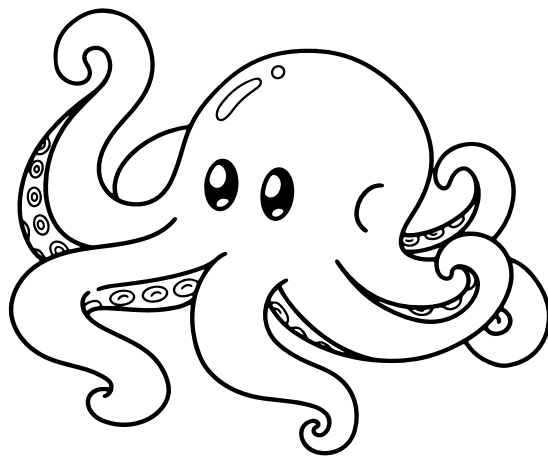
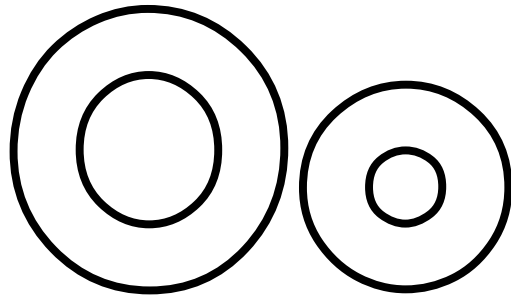

Octopus

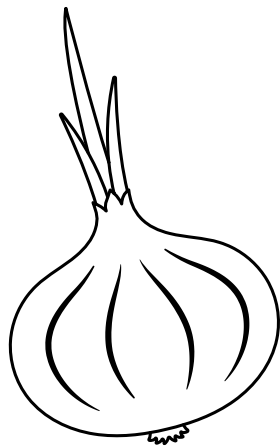

Onion

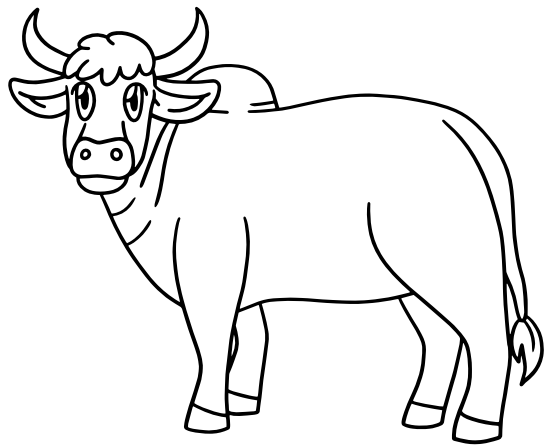

Ox

P

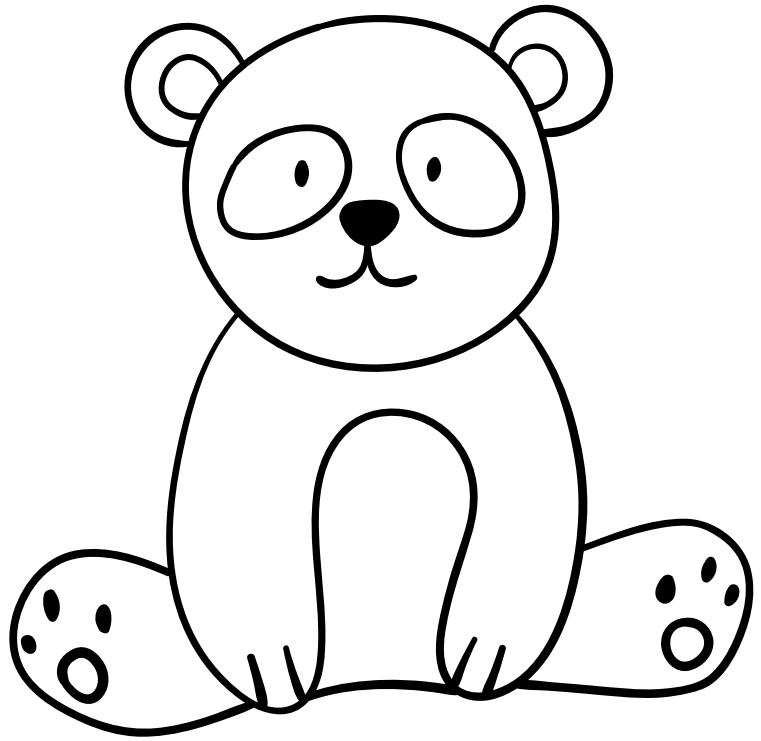

P p P p P p P p P p

P p P p P p P p P p

P p P p P p P p P p

P p P p P p P p P p

Color Me!

Pp

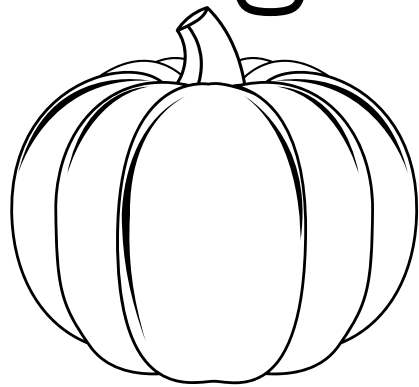

Pumpkin

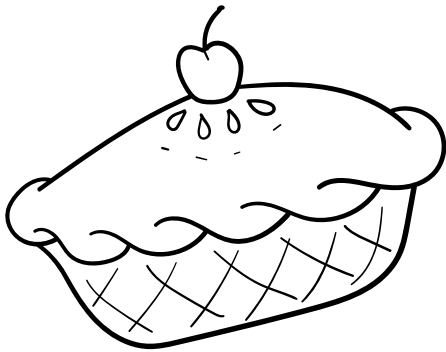

Pie

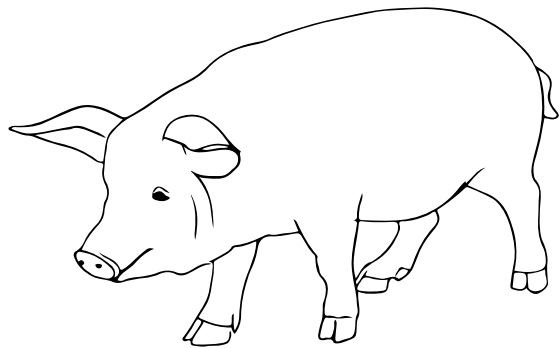

Pig

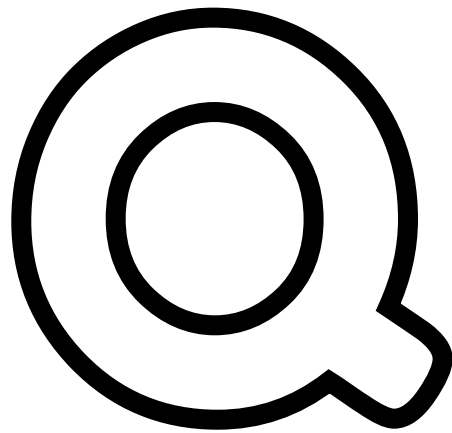
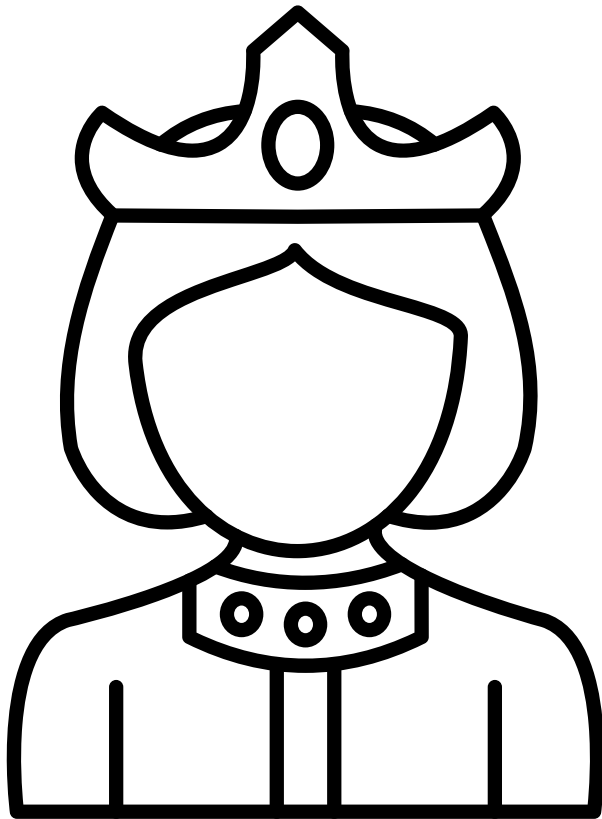

Q q Q q Q q Q q Q q

Q q Q q Q q Q q Q q

Q q Q q Q q Q q Q q

Q q Q q Q q Q q Q q

Color Me!

Qq

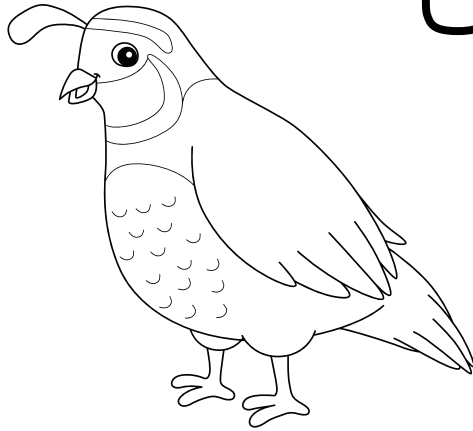

Quail

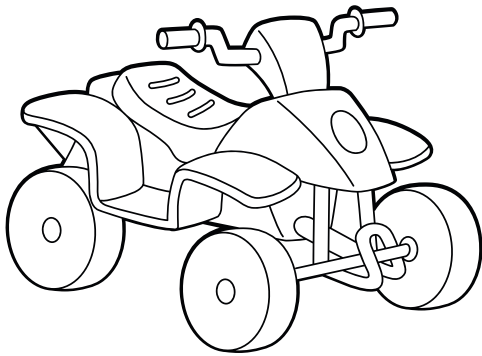

Quad



Quill

R

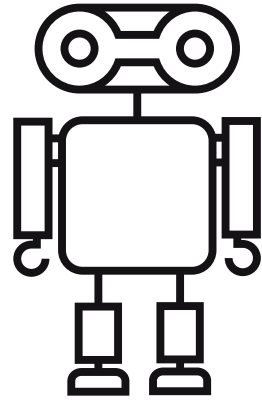
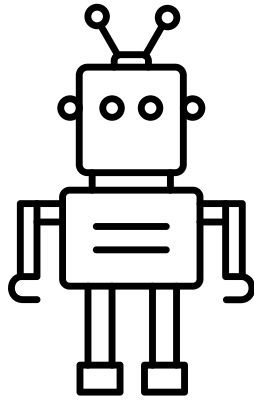
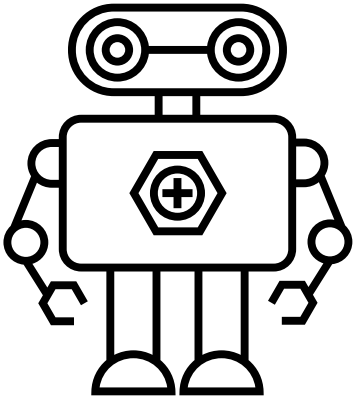

R r R r R r R r R r

R r R r R r R r R r

R r R r R r R r R r

R r R r R r R r R r

Color Me!

Rr

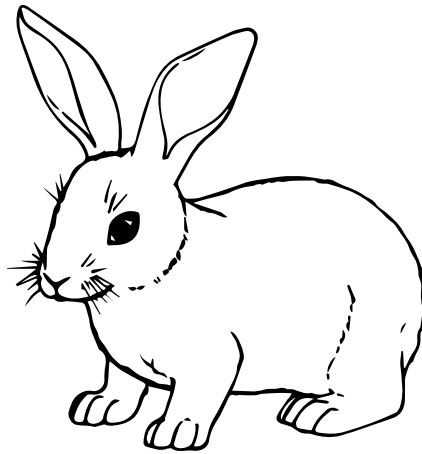

Rabbit

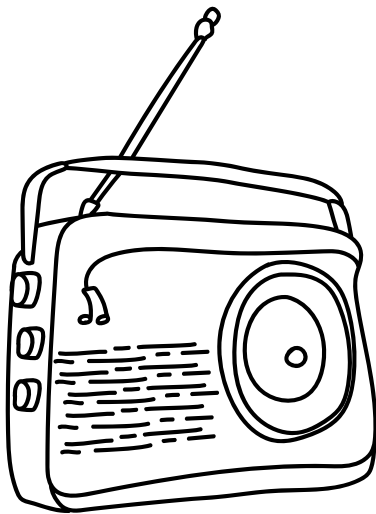

Radio

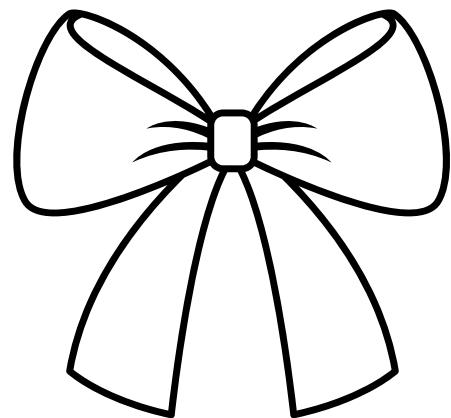

Ribbon

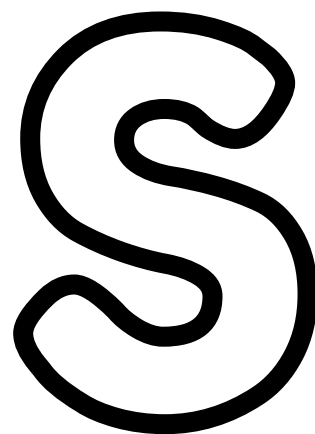
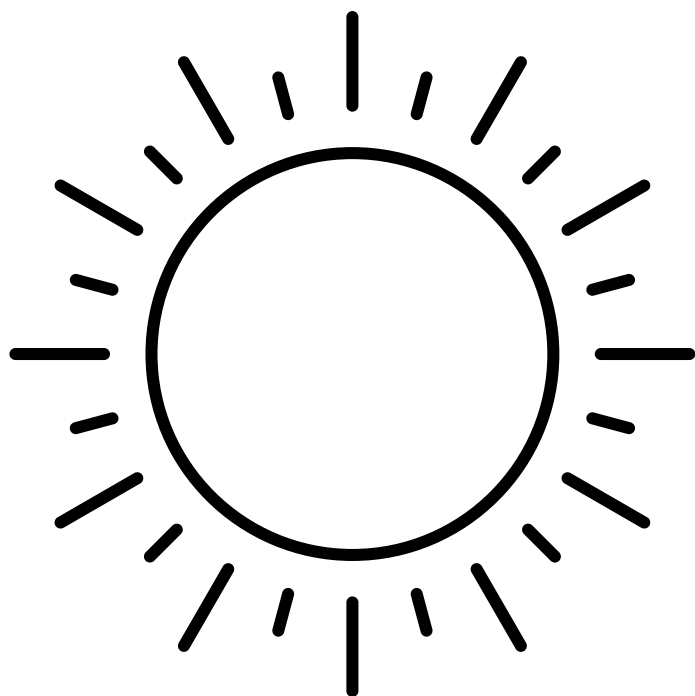

S s S s S s S s S s

S s S s S s S s S s

S s S s S s S s S s

S s S s S s S s S s

Color Me!

Ss

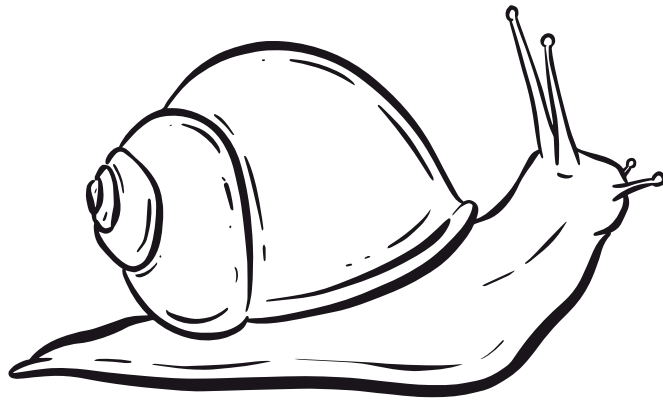

Snail

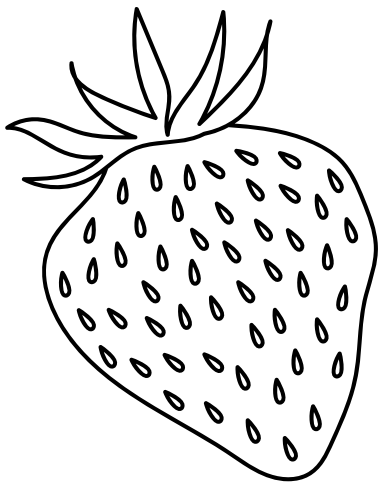

Strawberry

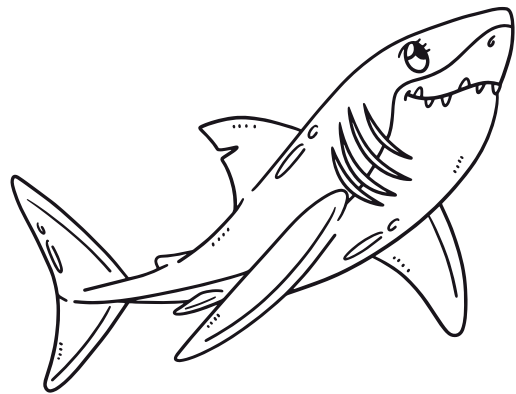

Shark

T

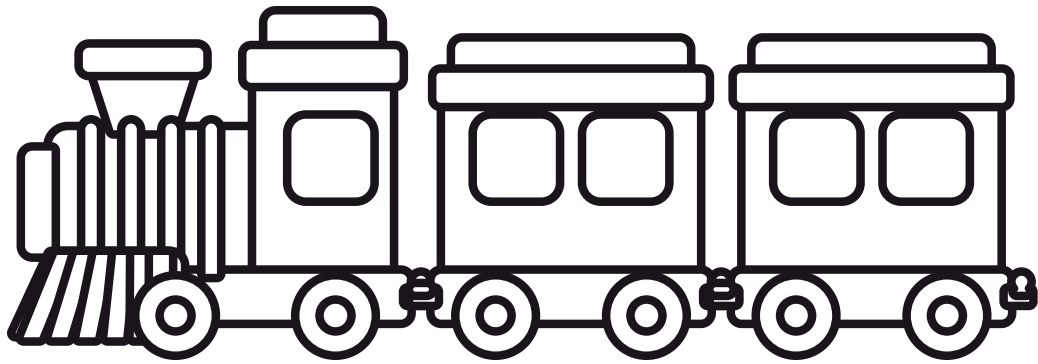

T T T T T T T T T T

T T T T T T T T T T

T T T T T T T T T T

T T T T T T T T T T

Color Me!

Tt

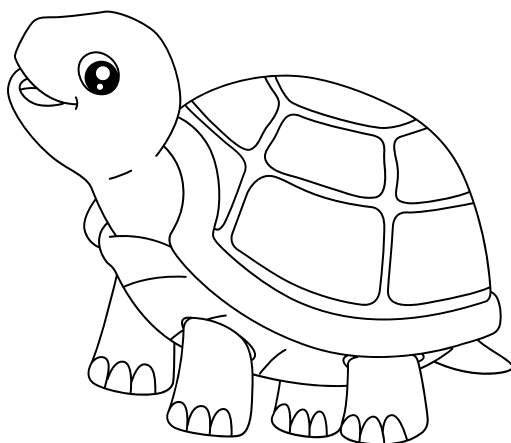

Turtle



Telephone

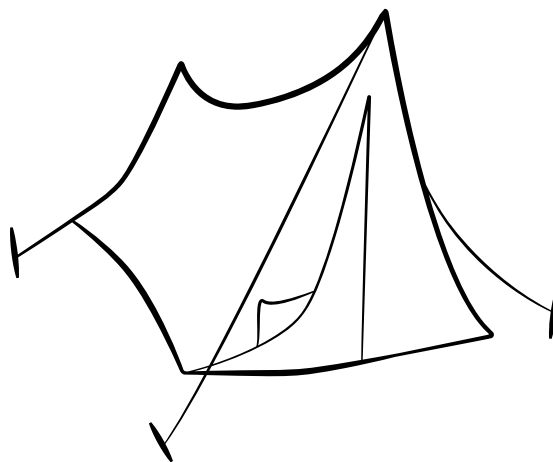

Tent

U



U u U u U u U u U u

U u U u U u U u U u

U u U u U u U u U u

U u U u U u U u U u

Color Me!

Uu

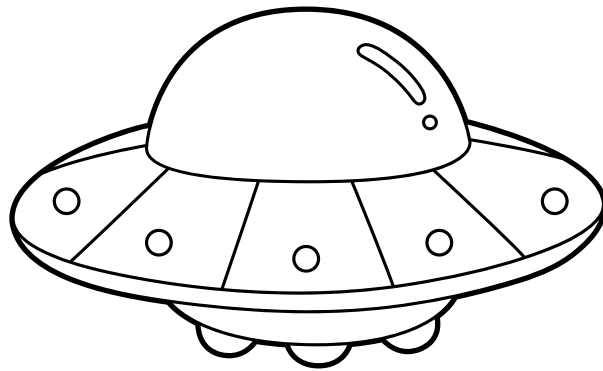

UFO



Unicorn

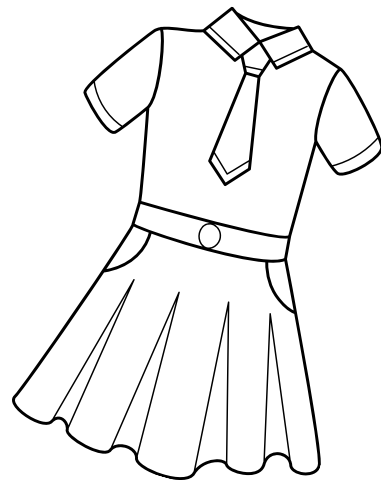

Uniform

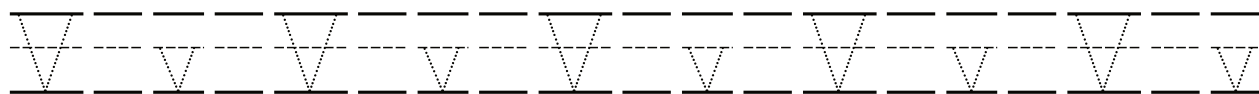
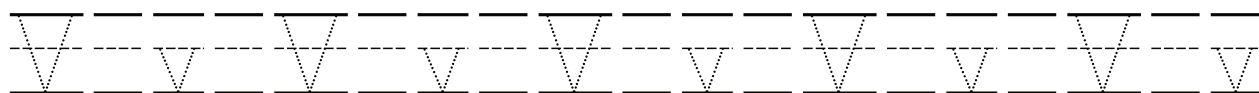
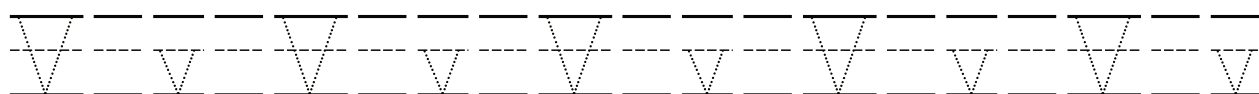
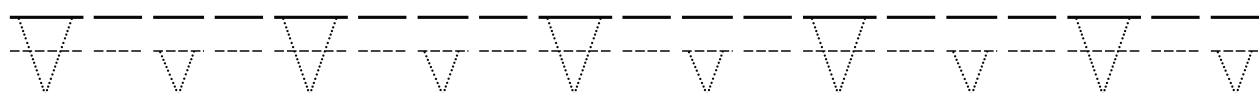
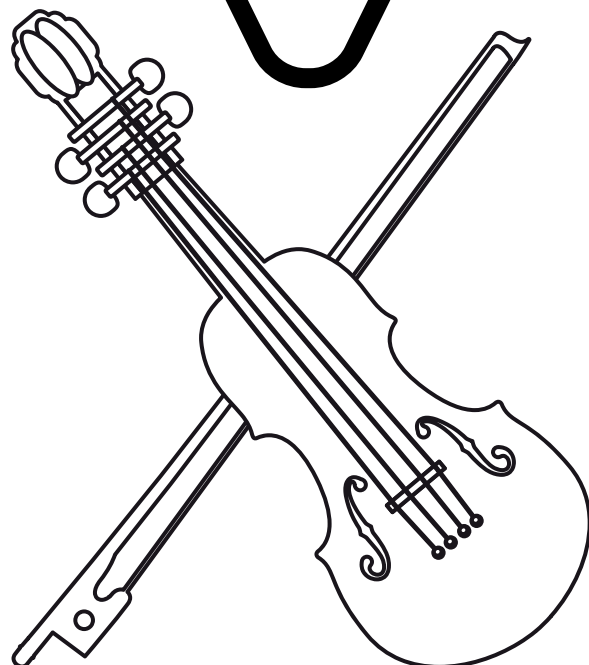

Color Me!

V v

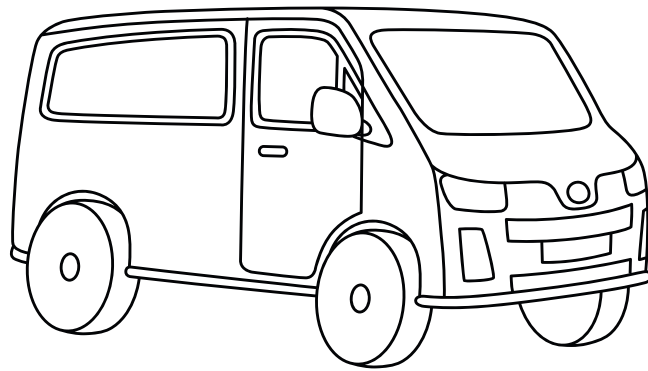

Van

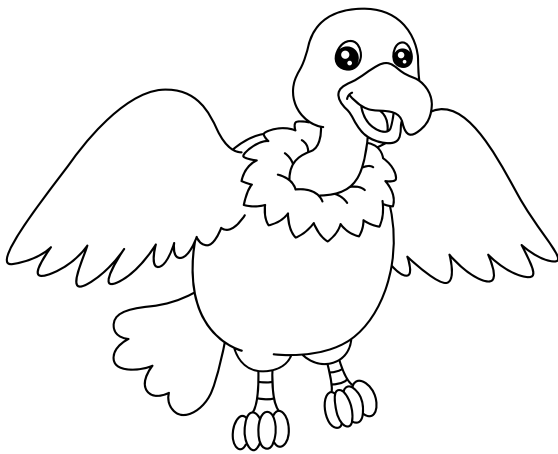

Vulture

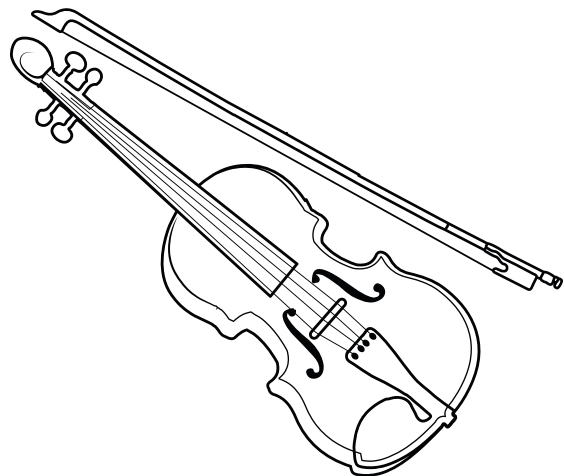

Violin

W



W w W w W w W w

W w W w W w W w

W w W w W w W w

W w W w W w W w

Color Me!

Ww

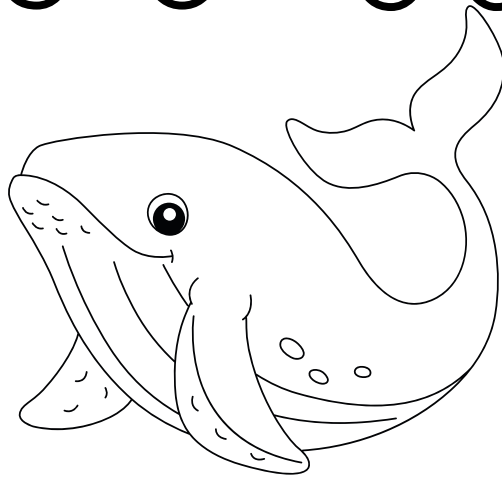

Whale

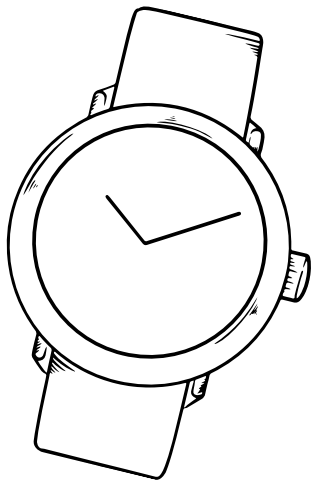

Watch

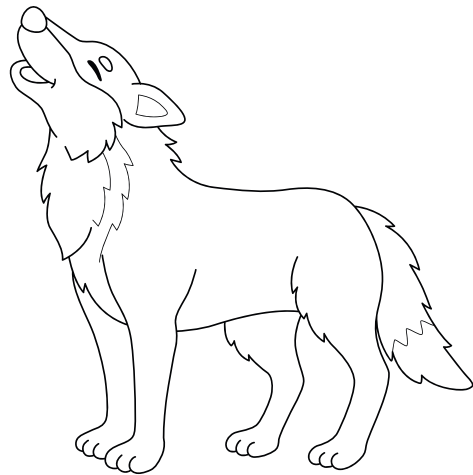

Wolf

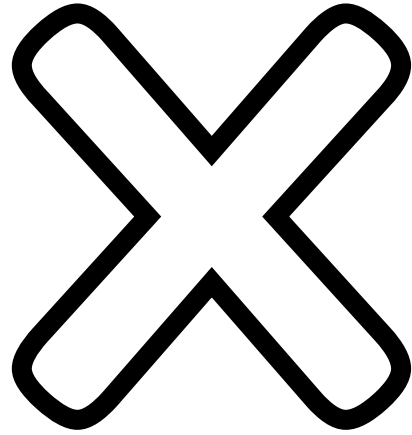
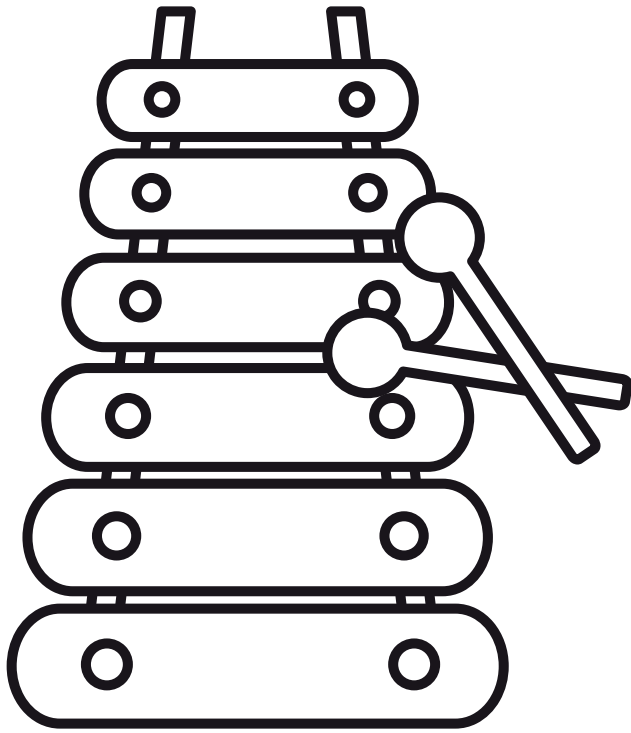

X x X x X x X x X x

X x X x X x X x X x

X x X x X x X x X x

X x X x X x X x X x

Color Me!

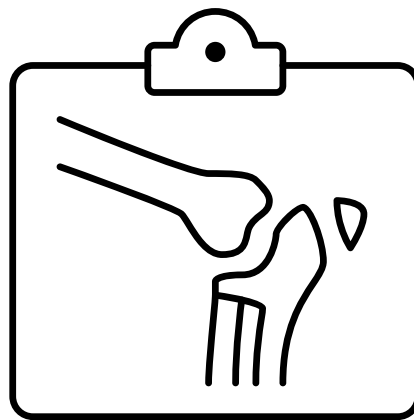
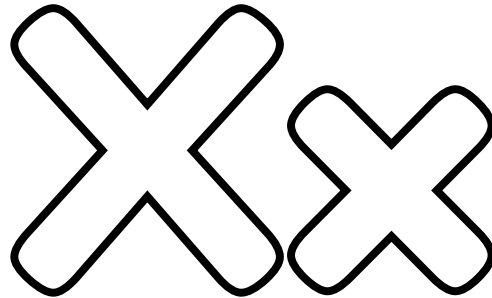

X-ray

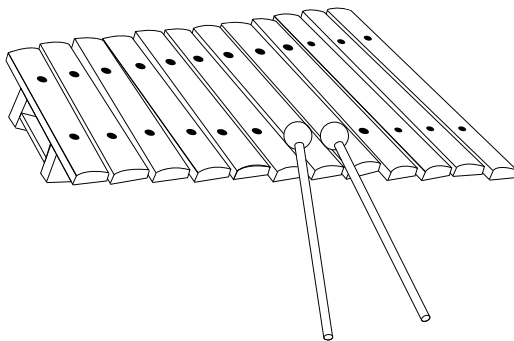

Xylophone



Ximenia

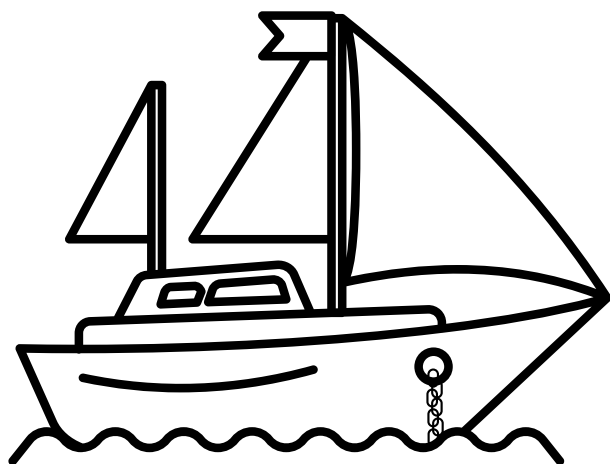

Y y Y y Y y Y y Y y

Y y Y y Y y Y y Y y

Y y Y y Y y Y y Y y

Y y Y y Y y Y y Y y

Color Me!

Yy

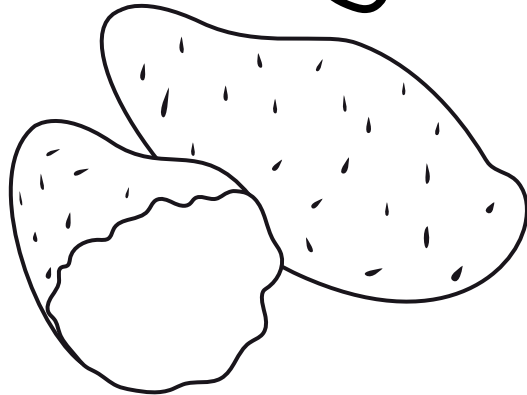

Yam

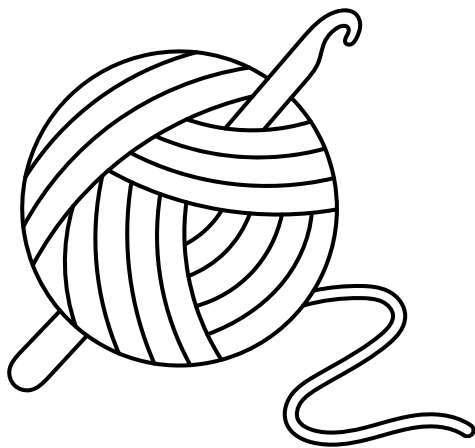

Yarn

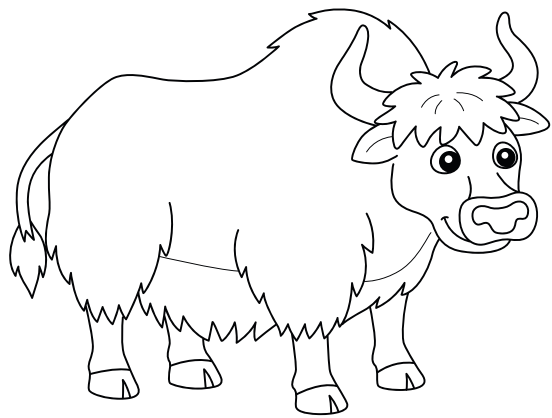

Yak

Z

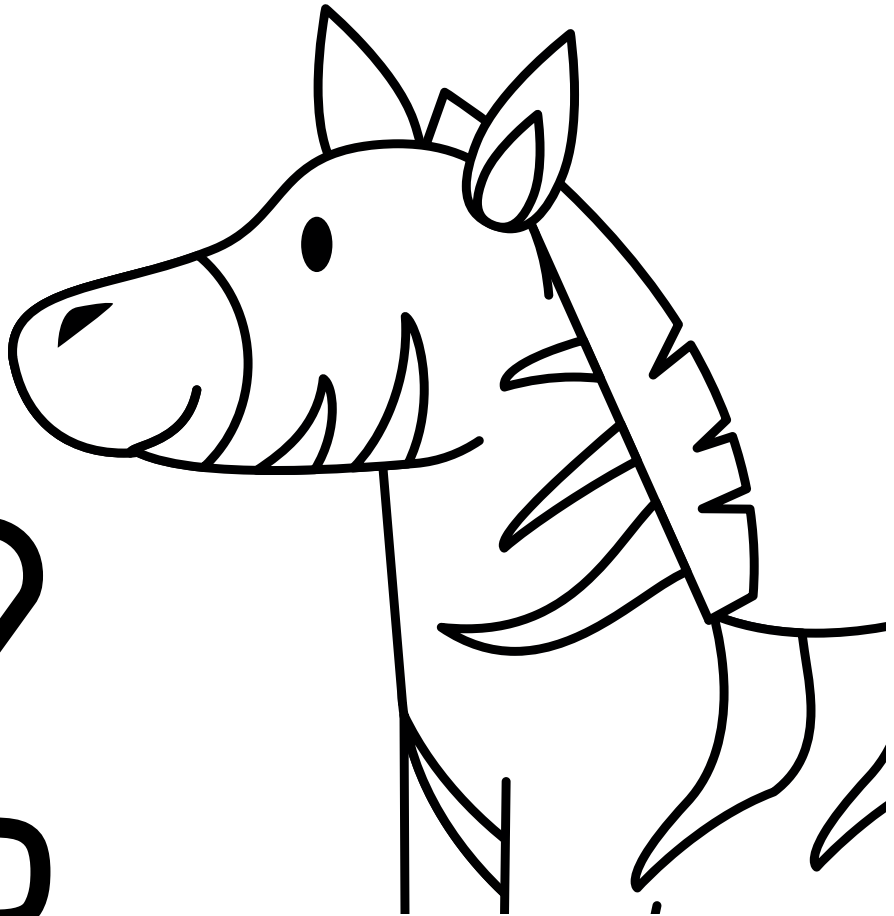

Z Z Z Z Z Z Z Z Z Z

Z Z Z Z Z Z Z Z Z Z

Z Z Z Z Z Z Z Z Z Z

Z Z Z Z Z Z Z Z Z Z

Color Me!

Zz

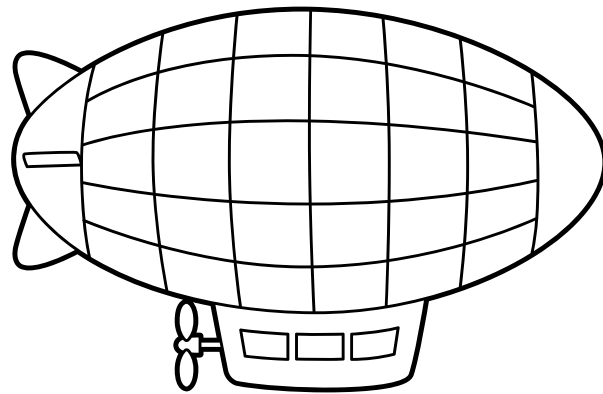

Zeppelin

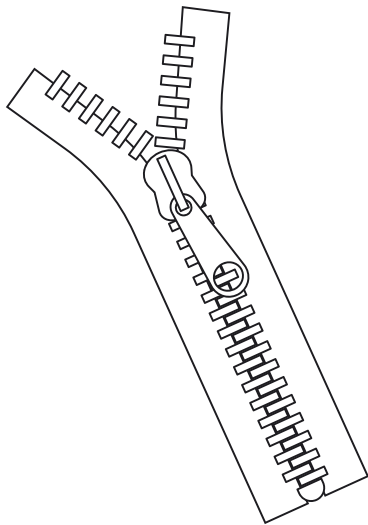

Zipper

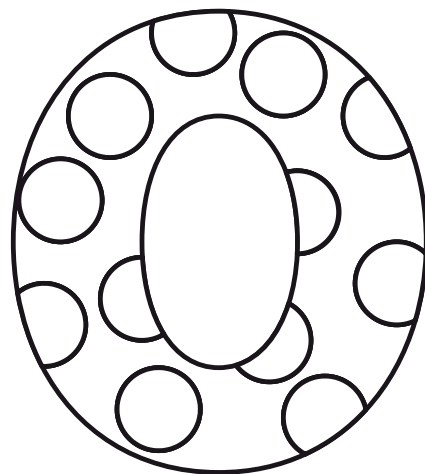

Zero

Letters of the Alphabet



Trace the letters.

Aa Bb Cc Dd

Ee Ff Gg Hh

Ii Jj Kk Ll

Mm Nn Oo Pp

Qq Rr Ss Tt

Uu Vv Ww Xx



Yy Zz

Let's Match Lowercase and Uppercase Letters

Draw line to match the lowercase and uppercase letters.
Color the matching puzzle pieces.

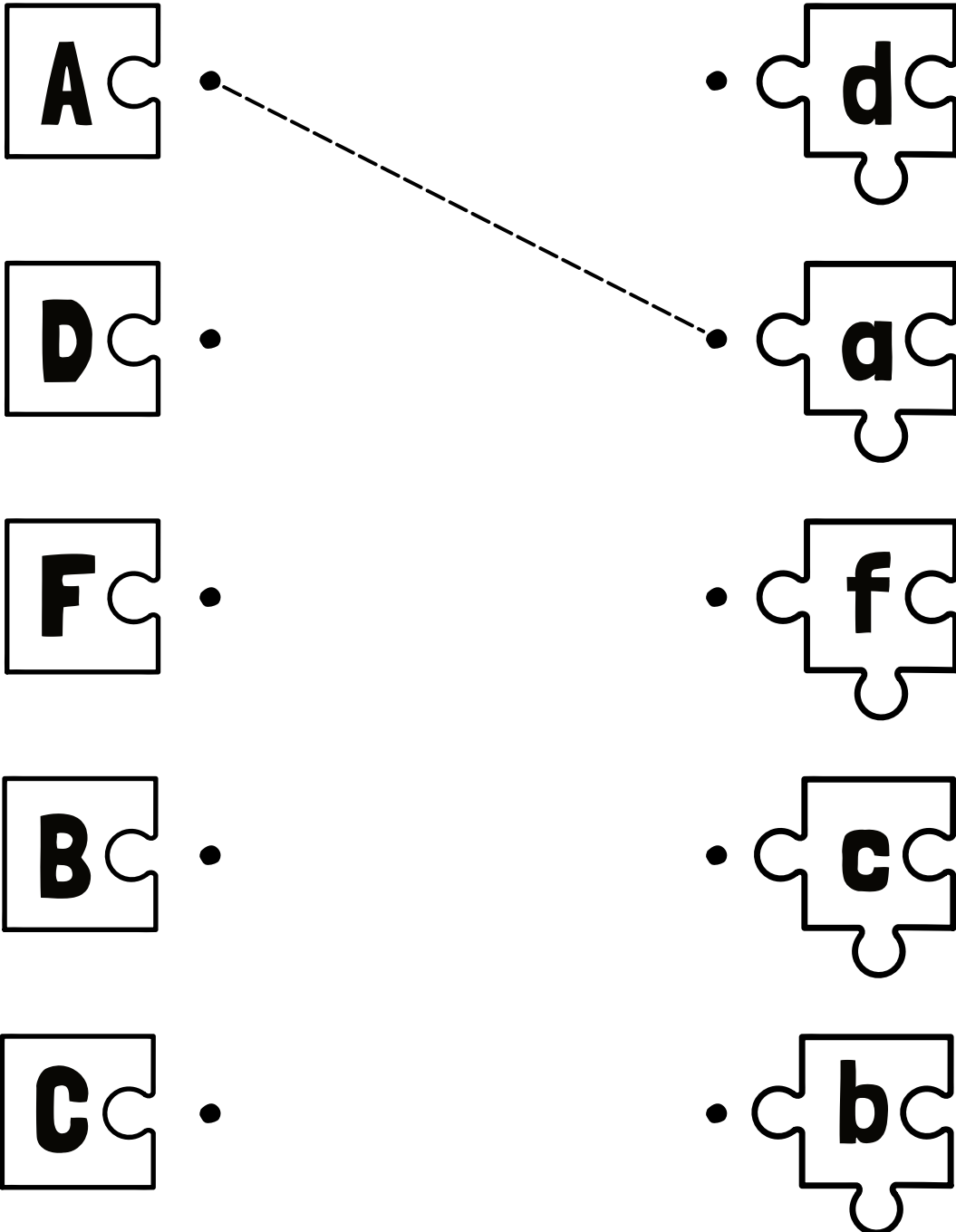

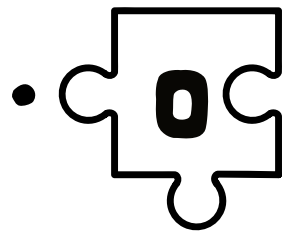
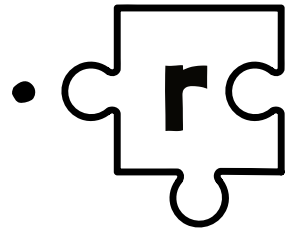
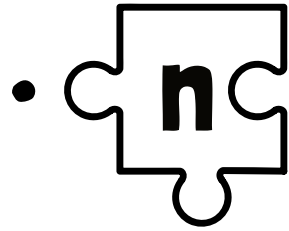
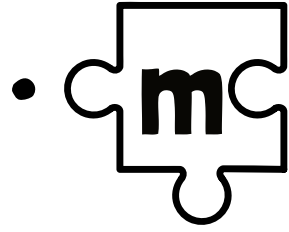
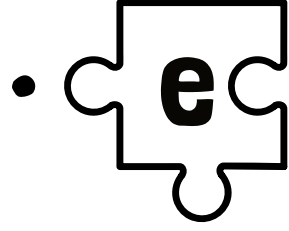
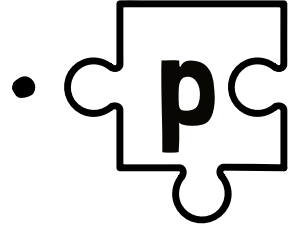
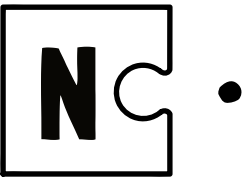
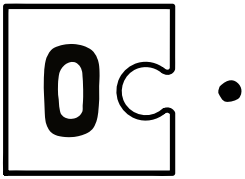
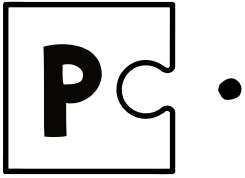
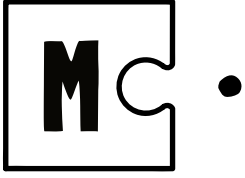
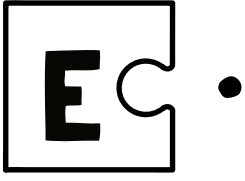

K C .

T C .

V C .

W C .

U C .

Z C .

. **v** C

. **u** C

. **k** C

. **t** C

. **z** C

. **v** C

Beginning sounds

Look at the pictures and complete the words with the missing letters.

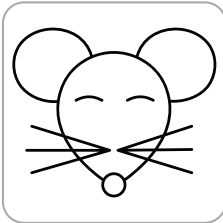

A T



E E

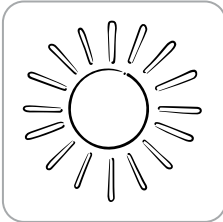

U N

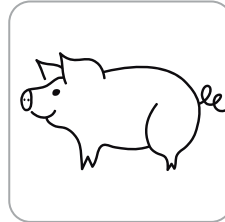

I G



U P



A P

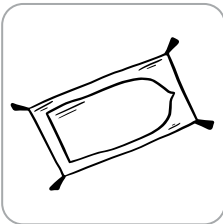

U G

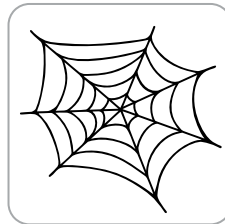

E B

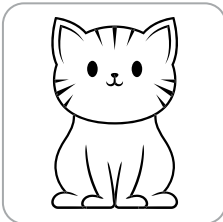

A T



O T

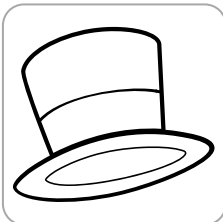

A T



A M

CVCC WORDS

Write the beginning sound of each picture.

b

c

f

g

h

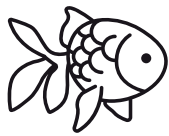

__ish

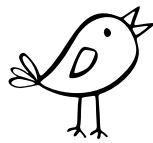

__ird



__arm



__orn



__and



__ift



__amp



__olf



__arp

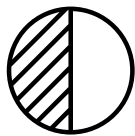

__alf

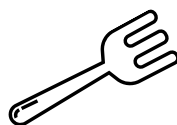

__ork

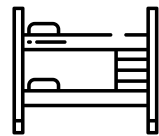

__unk

Short Vowels

a

e

i

o

u

Write the middle sound of each picture.

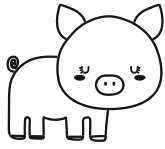
	p__g
---	------

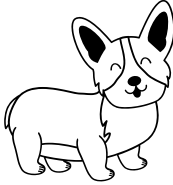
	d__g
--	------

	b__s
---	------

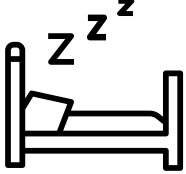
	b__d
---	------

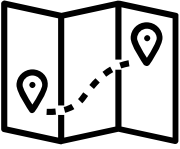
	m__p
---	------

	b__g
--	------

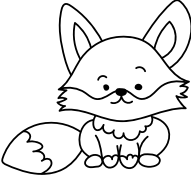
	f__x
---	------

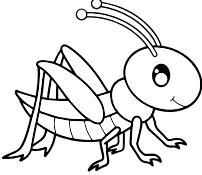
	b__g
--	------

	l__g
---	------

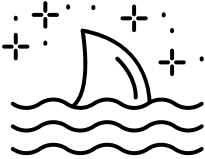
	f__n
--	------

Spring Matching

Match the same elements.

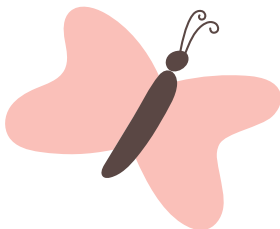
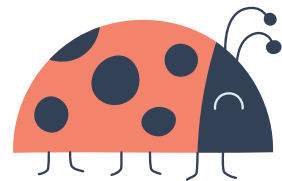
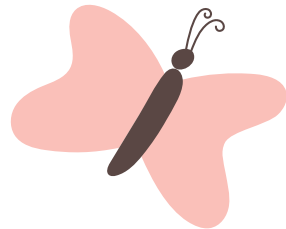
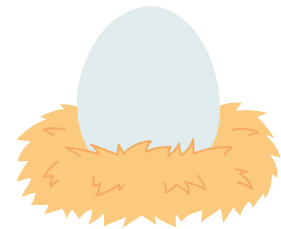

Match

Draw a line from picture on left to the matching picture on right.

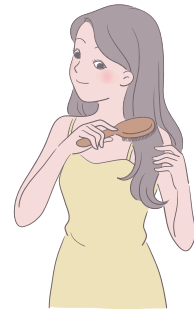

Match

Draw a line from picture on left to the matching picture on right.

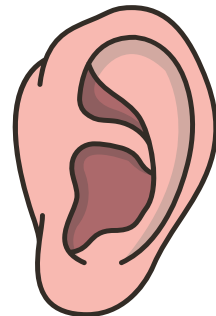
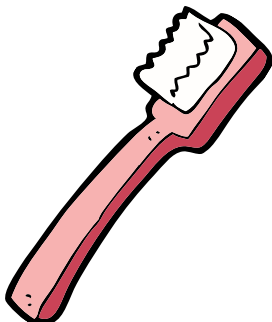
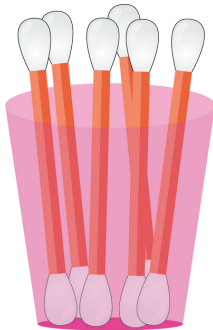
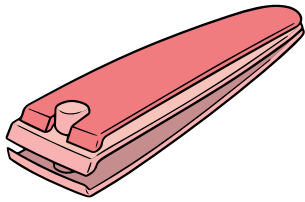

Color Matching

Match the dinosaurs with their colors.

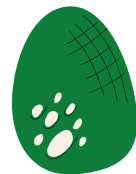
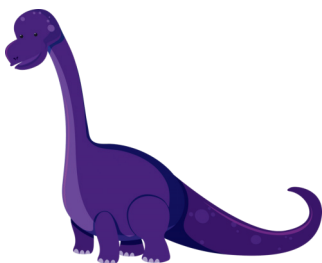
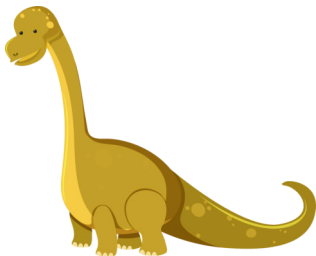
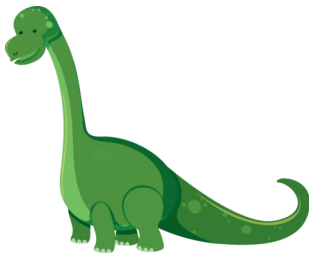
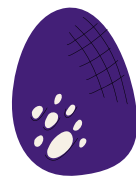



Butterflies

- Match the same colored butterflies.

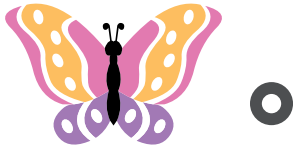

Match the colors to the fruits to the right.

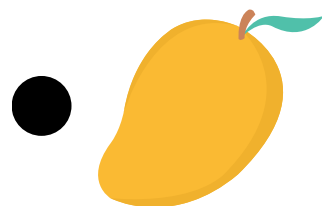
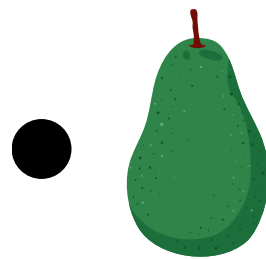
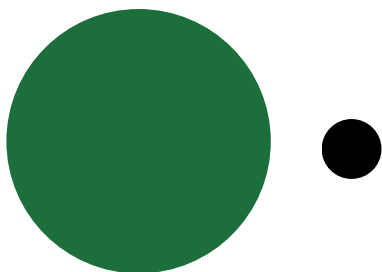
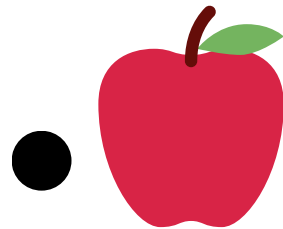
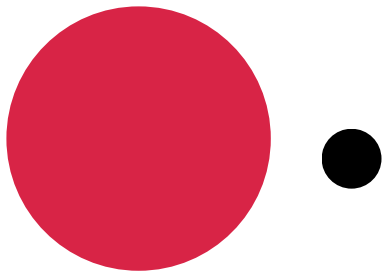
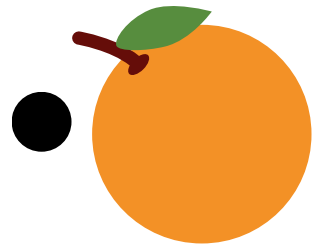
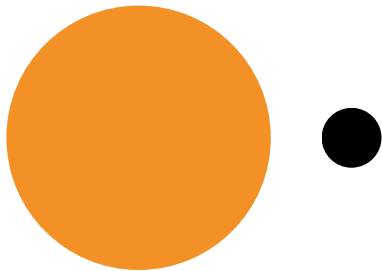

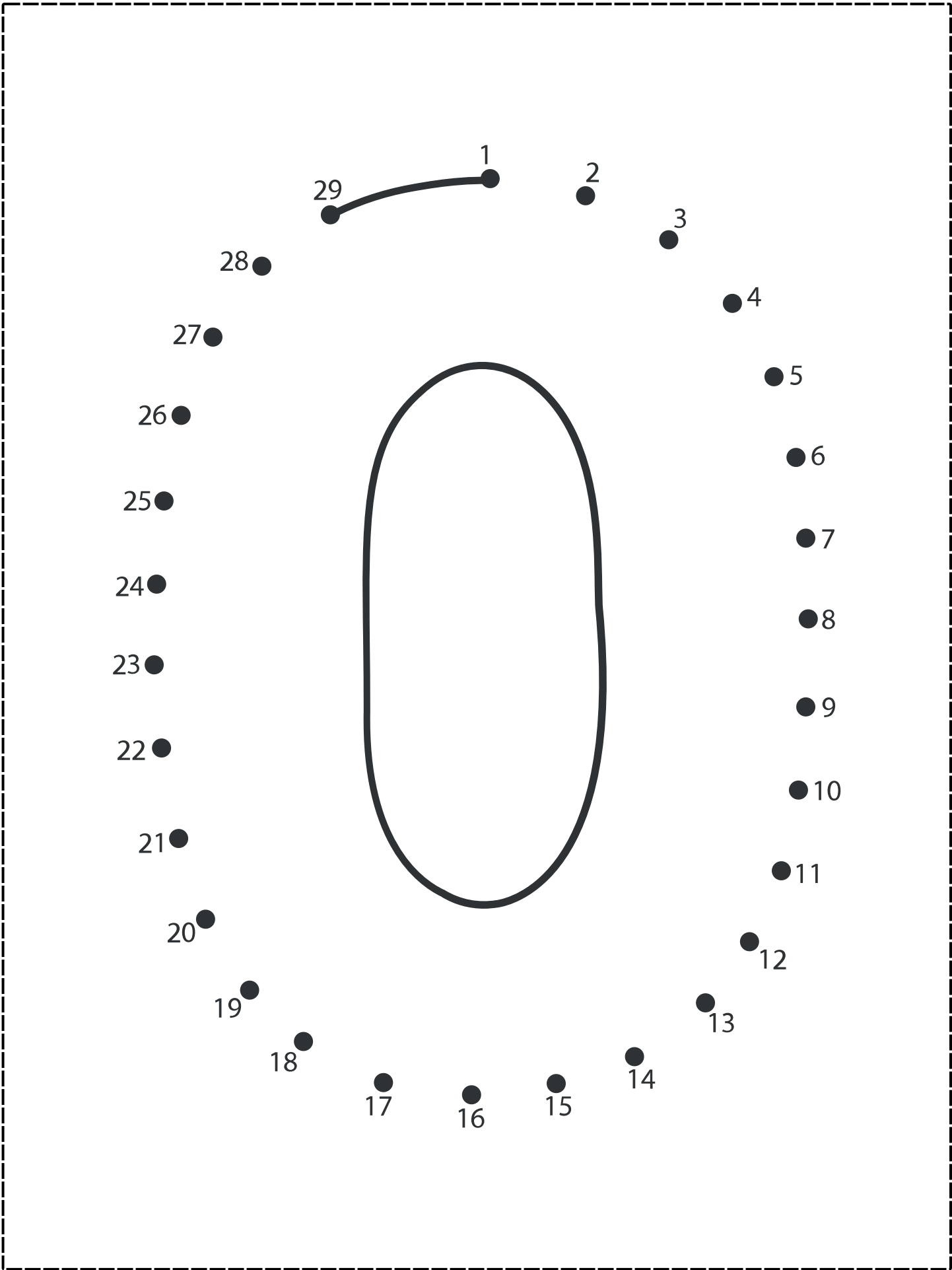

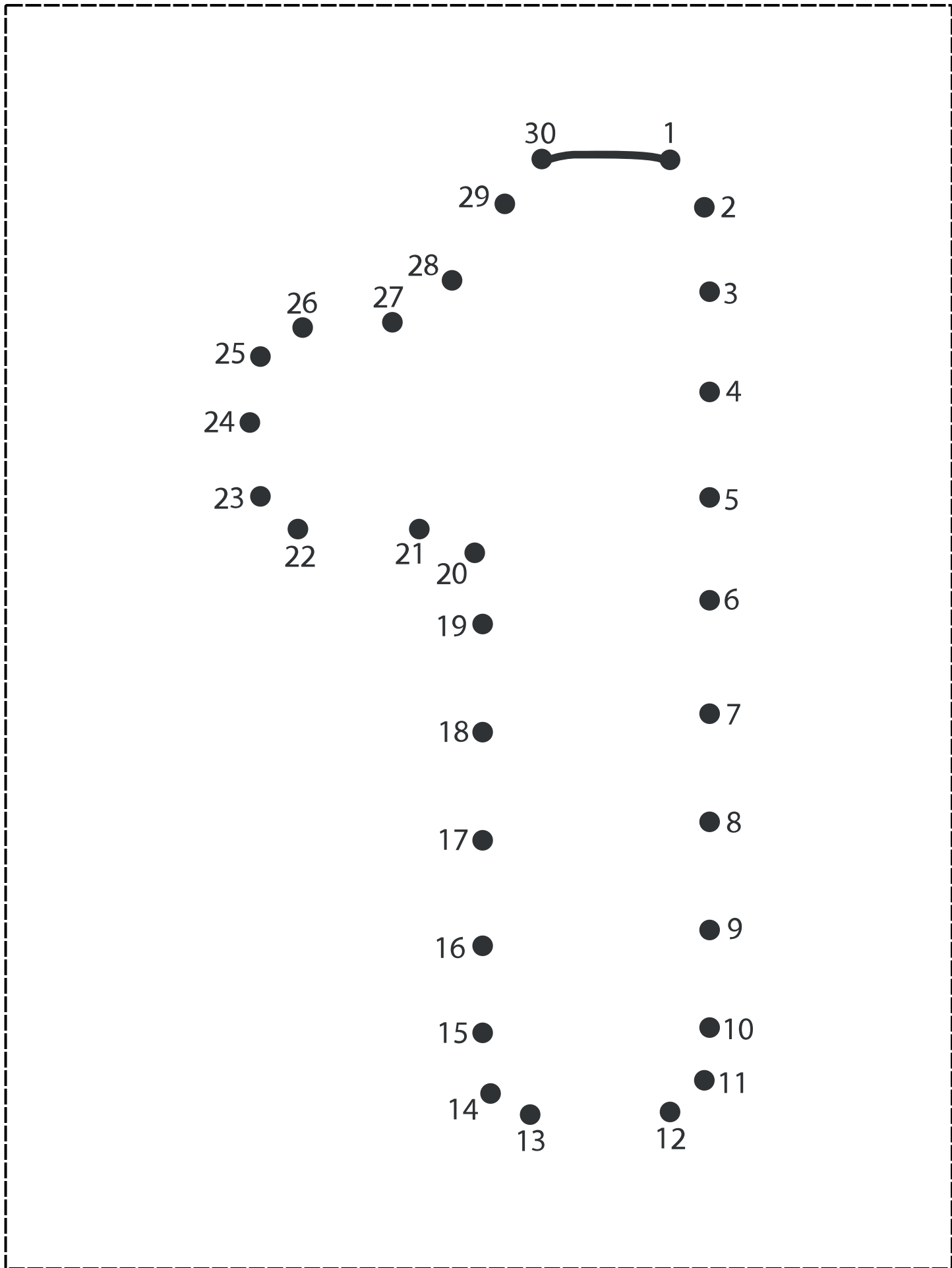

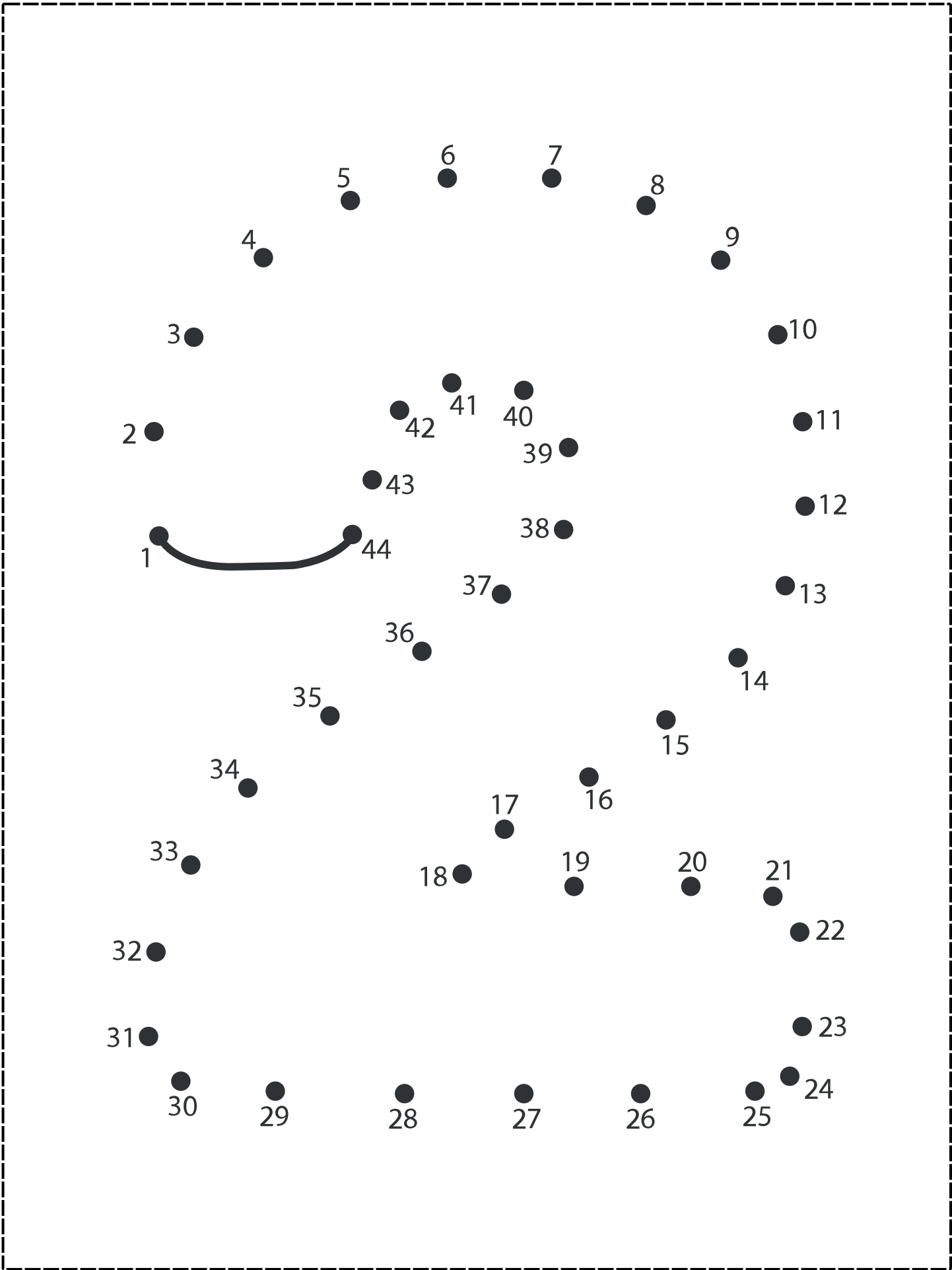

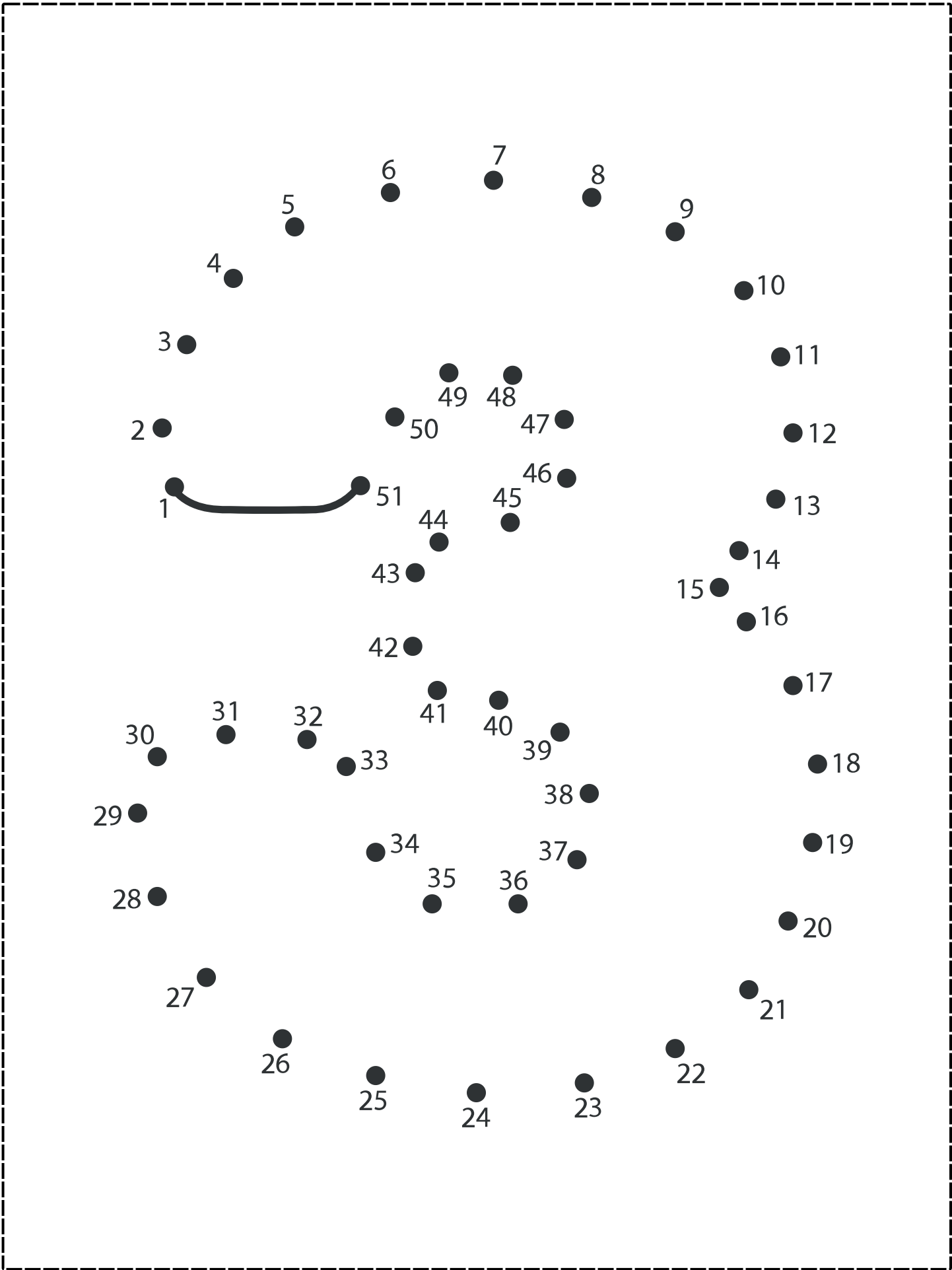

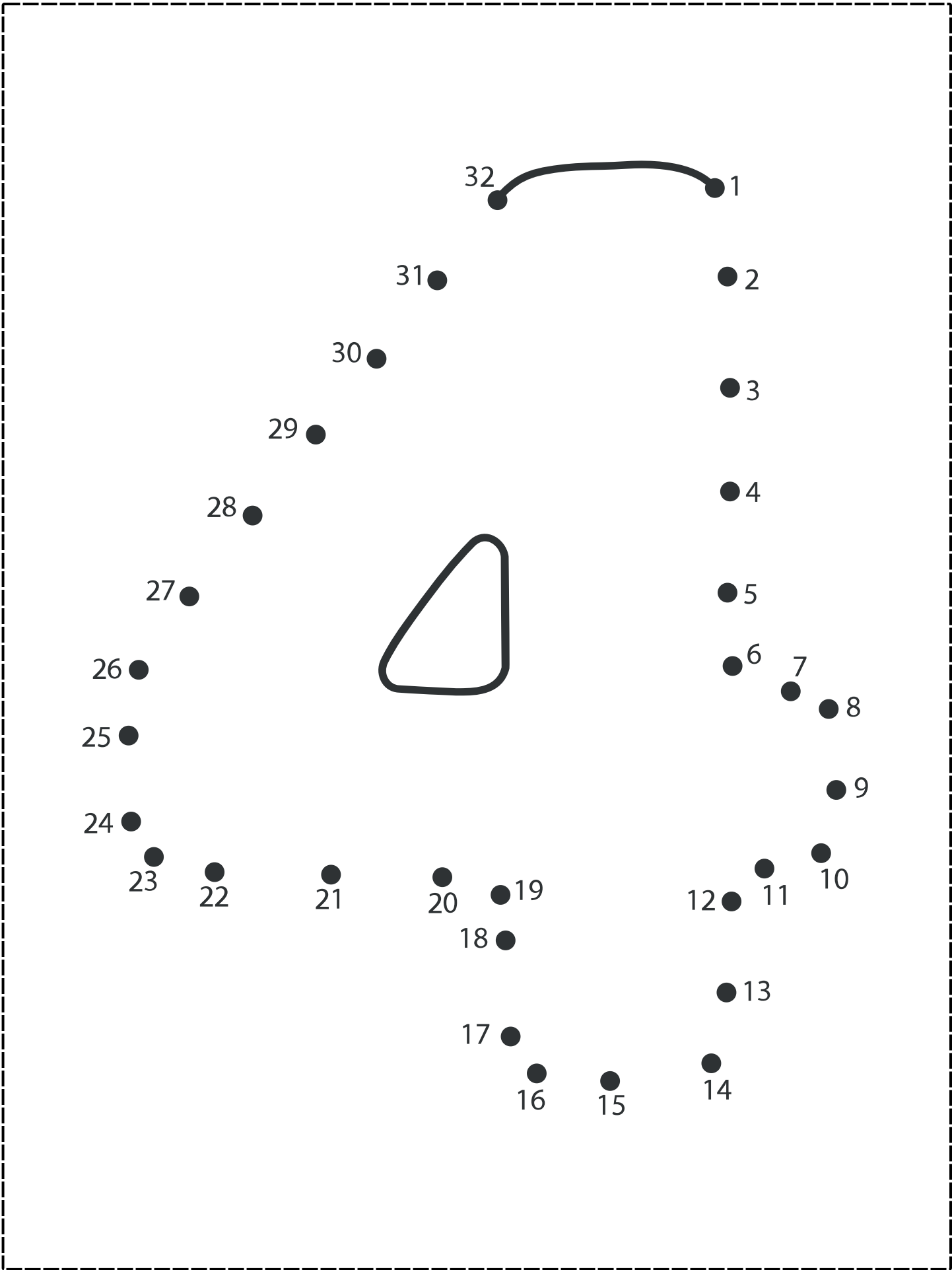

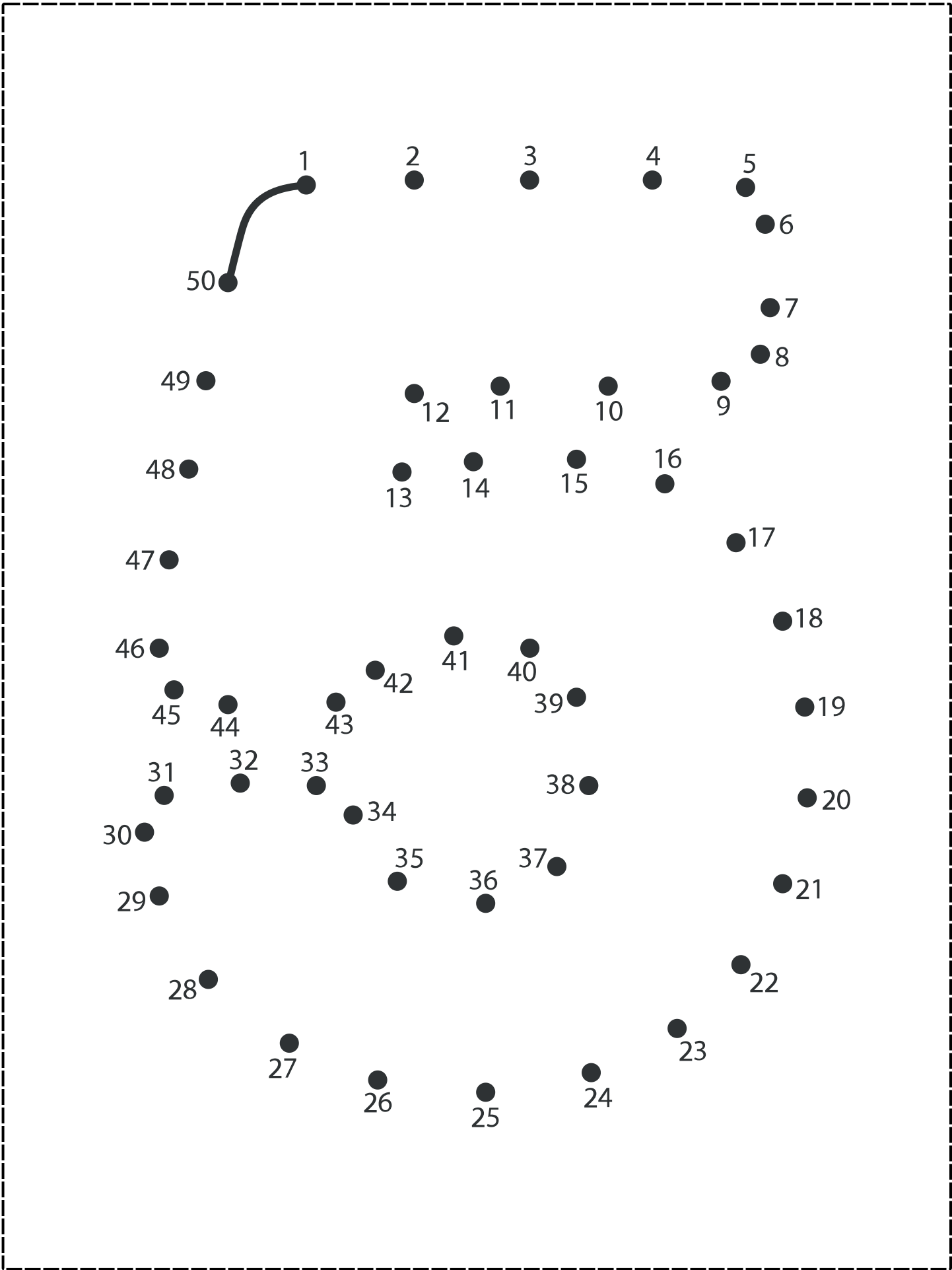

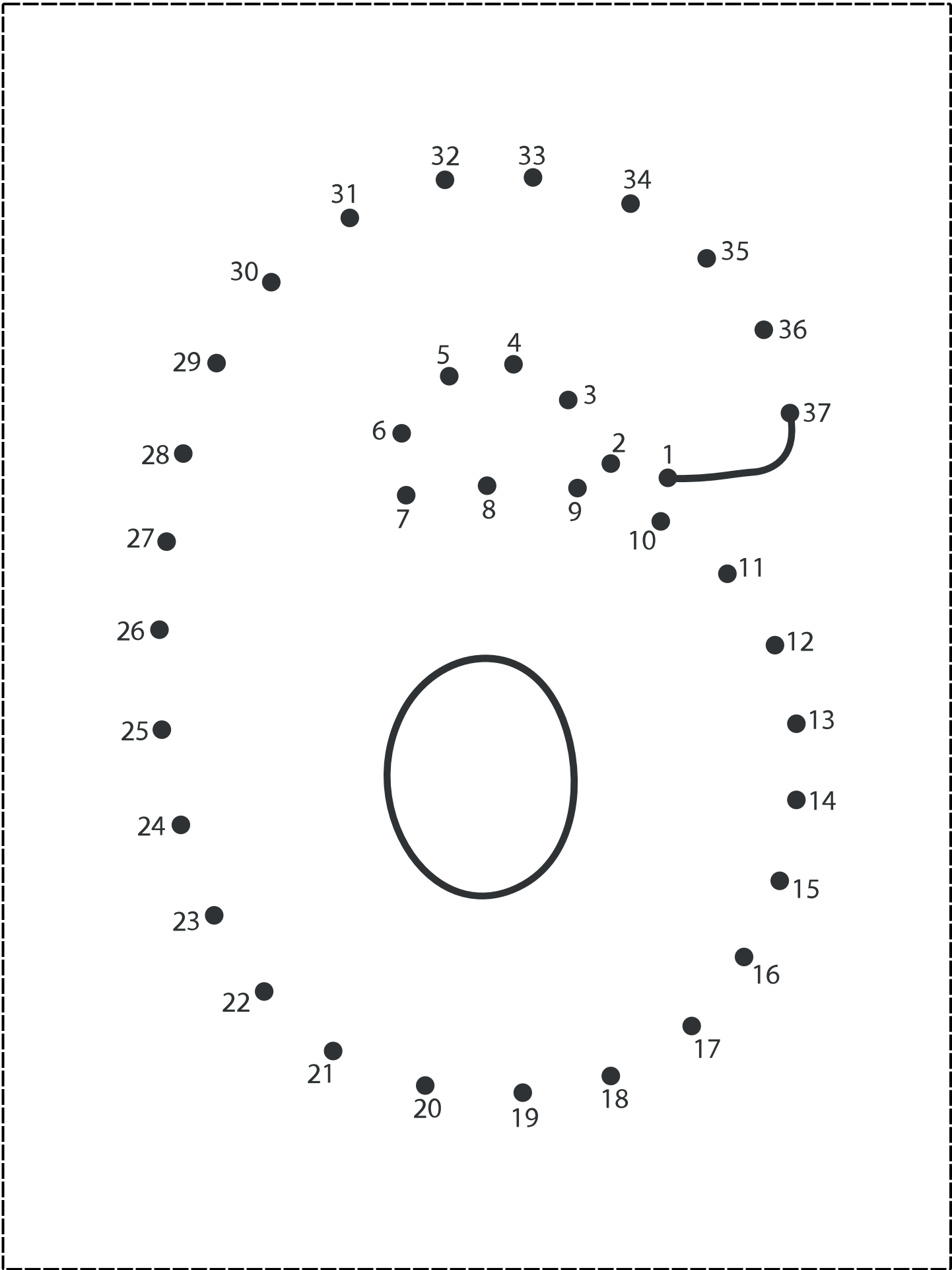



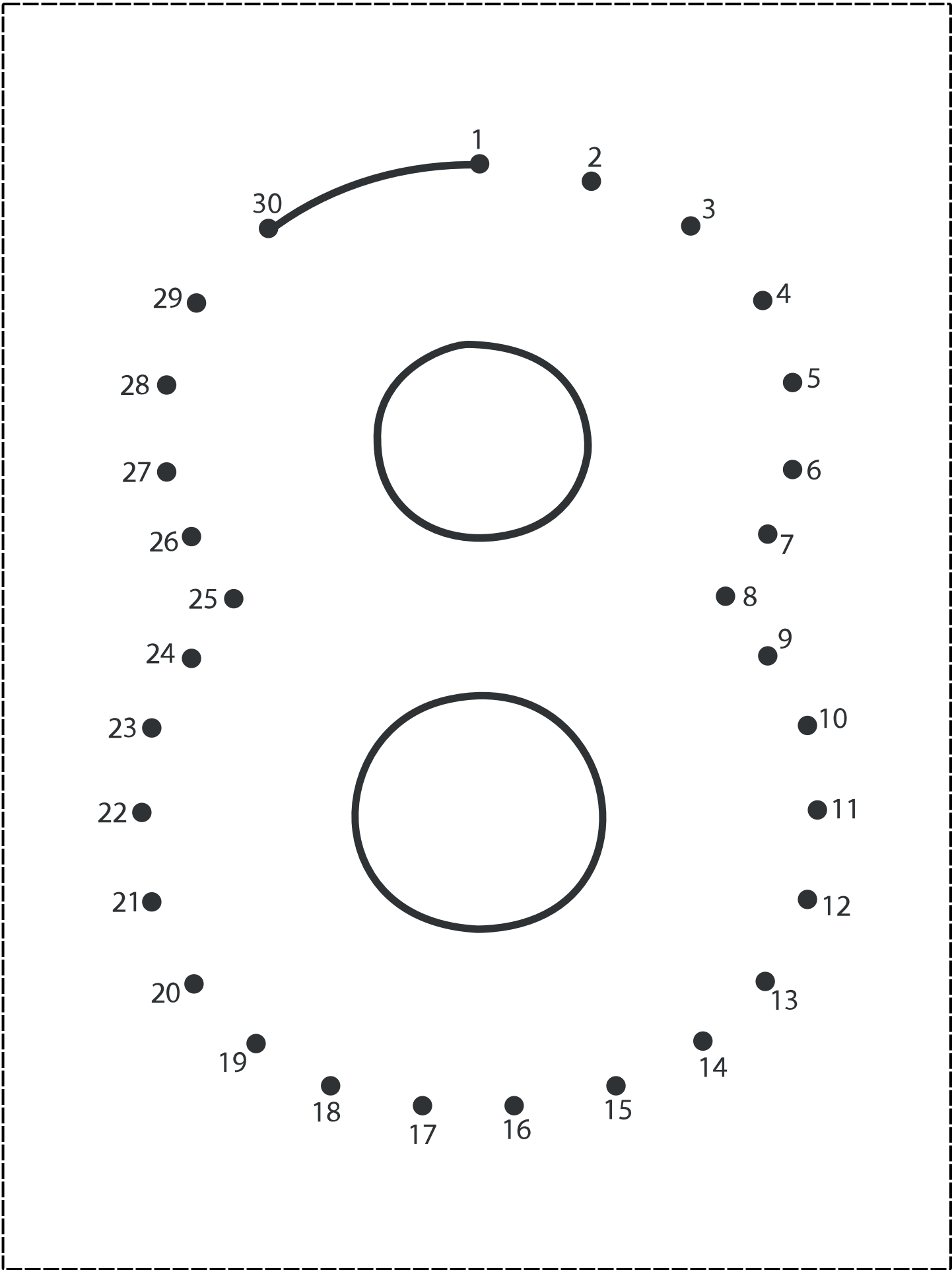

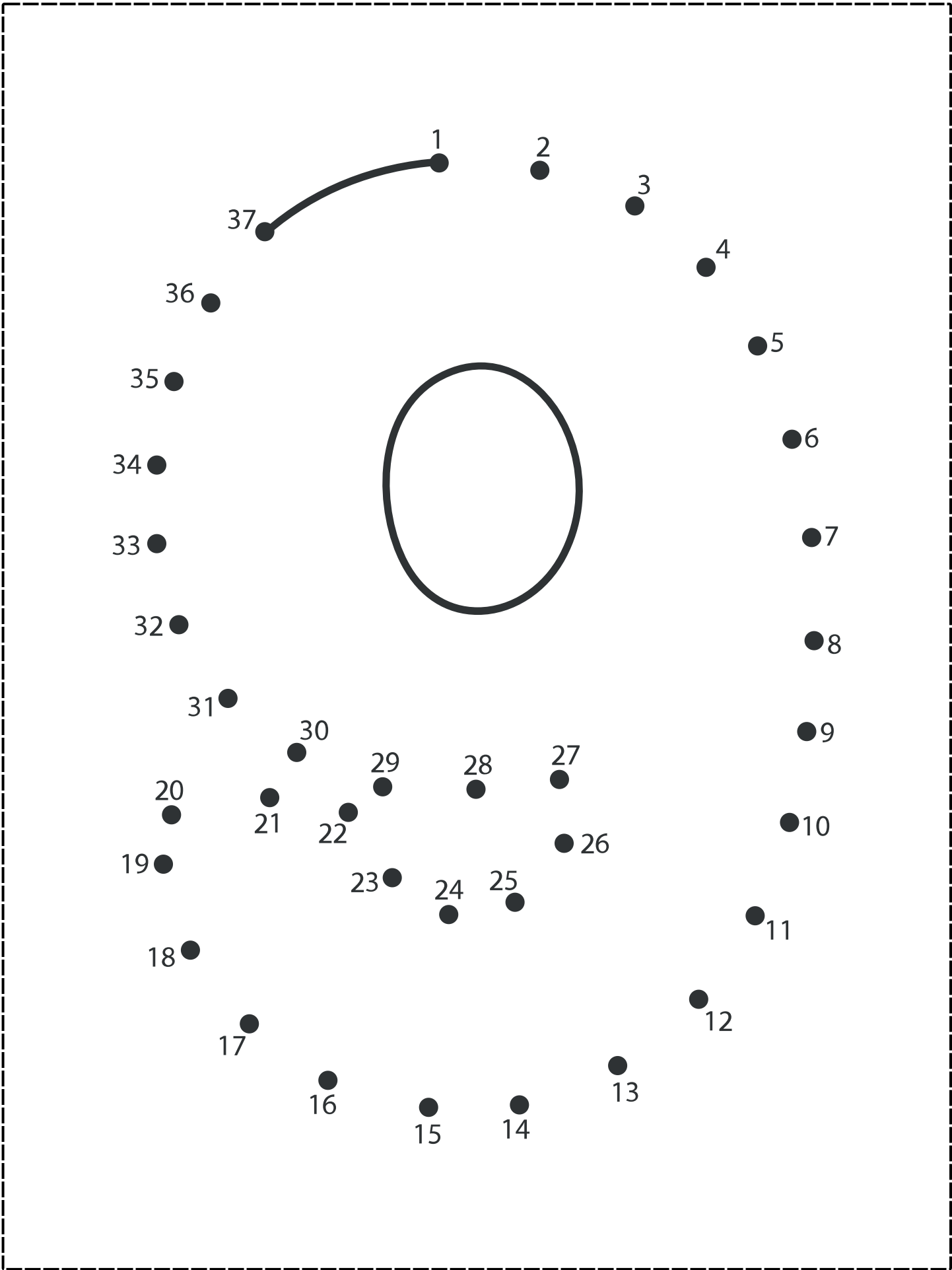

NUMBERS TO 30

Fill in the missing numbers : _____

1			4	
		8		
				15
	17		19	
20		23		
26			29	30

NUMBERS TO 60

Fill in the missing numbers : _____

31				35
	37			
	42			45
46			48	
51			54	
		55		60

WRITING NUMBERS

Write the numbers 1 to 10.

1	2	3	4	5
6	7	8	9	10

WRITING NUMBERS

Write the numbers 1 to 10.

11

12

13

14

15

16

17

18

19

20

NUMBER ORDER

Fill in the missing number in the sequence.

1		3		
		8		10
11			14	
16			19	

NUMBER ORDER

Fill in the missing number in the sequence.

1				5
6				10
11		13		
	17			20

NUMBER ORDER

Fill in the missing number in the sequence.

11			14	
		18		20
21		23		
26		25		

NUMBER ORDER

Fill in the missing number in the sequence.

11	12			
	17			
21				25
				30

Number Bonds

Write the missing number to make 10.

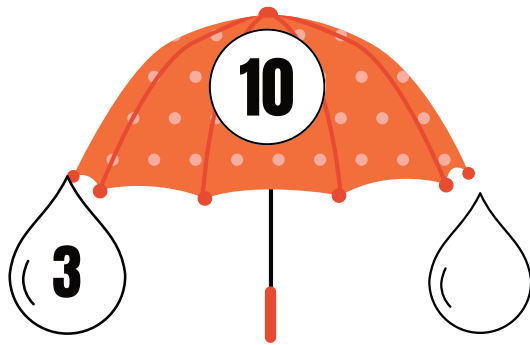

Number Bonds

Write the missing number to make 10.

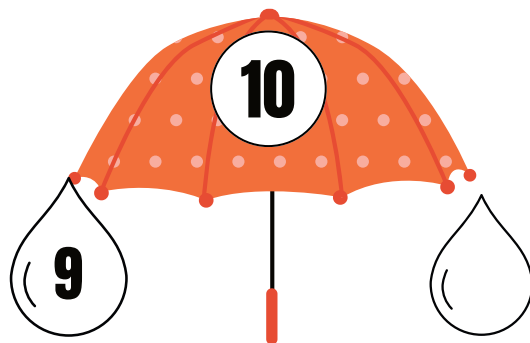
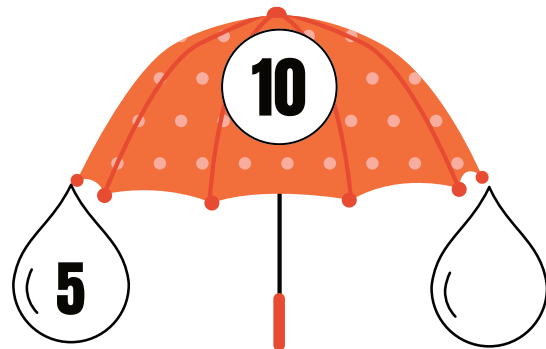

SUBTRACTION

Subtract and write the correct answer in the box.

$2-1 =$

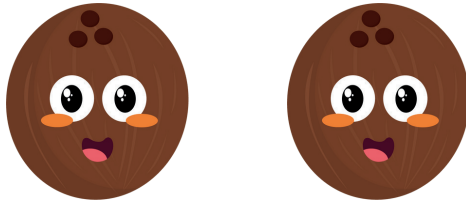

$3-1 =$



$4-3 =$

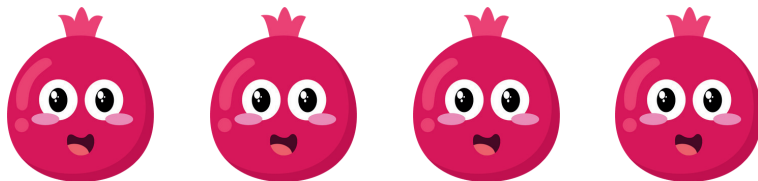

$5-1 =$



$4-2 =$

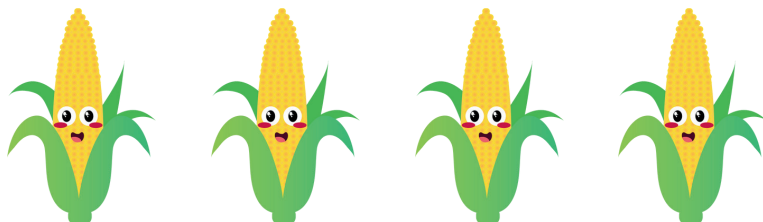

SUBTRACTION

Subtract and write the correct answer in the box.

$3-1 =$



$3-2 =$



$2-1 =$



$5-2 =$



$4-4 =$



SUBTRACTION

Subtract and write the correct answer in the box.

$9-5 =$

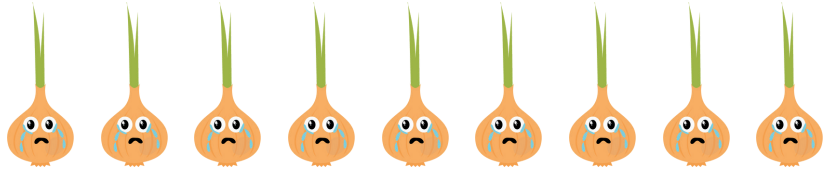

$12-6 =$

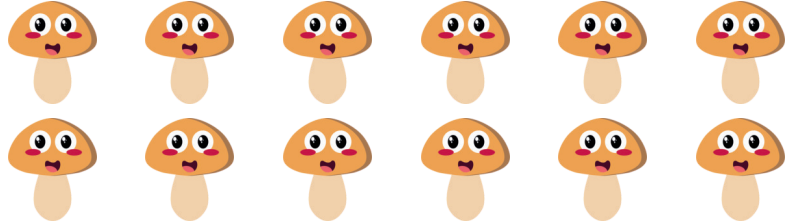

$10-6 =$

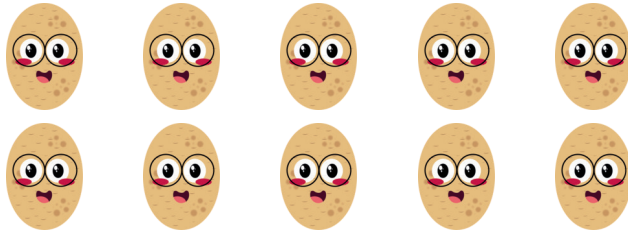

$5-5 =$



$7-3 =$

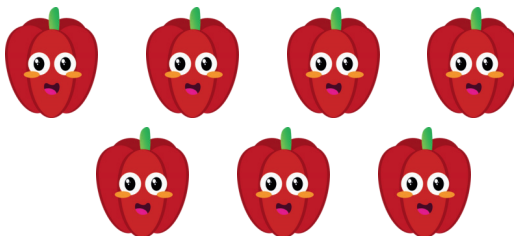

SUBTRACTION

Subtract and write the correct answer in the box.

$7-4 =$

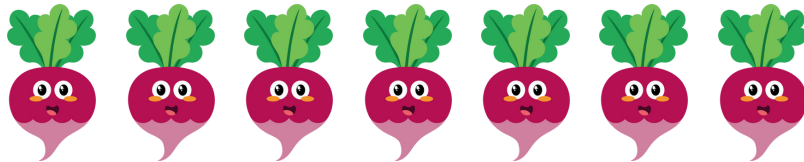

$13-5 =$

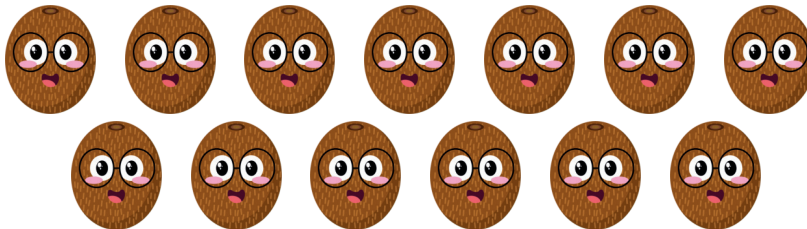

$11-6 =$



$7-4 =$



$6-3 =$



Colors

Look and write the names of the colors

GRAY

YELLOW

BROWN

GREEN

BLUE

PURPLE

BLACK

WHITE

PINK

ORANGE

RED

LIGHT BLUE

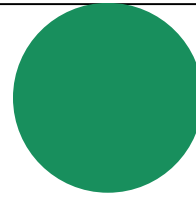
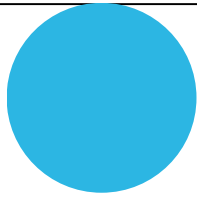
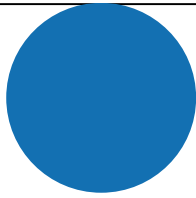
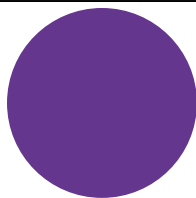
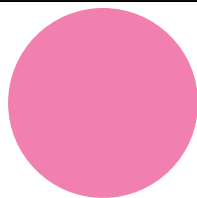
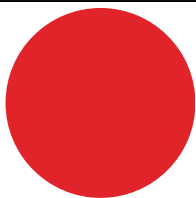
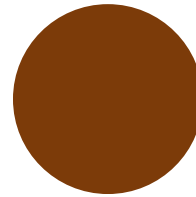
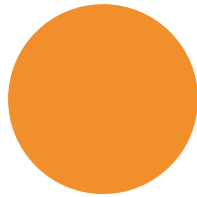
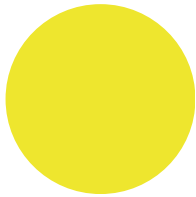
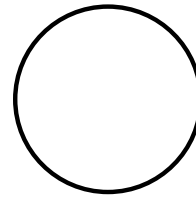
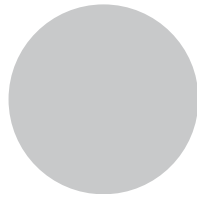
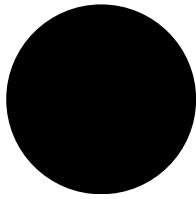

Match the colors shown in the picture on the left.

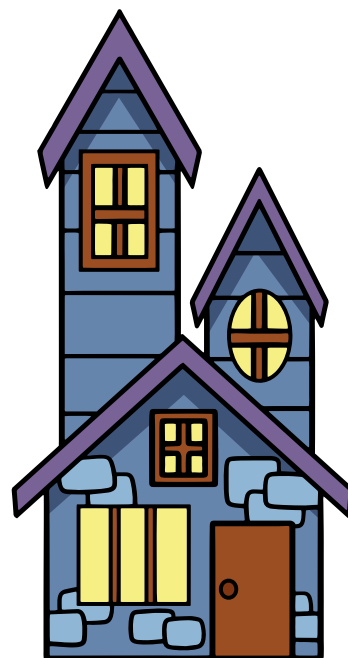

Match the colors shown in the picture on the left.



Match the colors shown in the picture on the left.



Match the colors shown in the picture on the left.



Match the colors shown in the picture on the left.



Match the colors shown in the picture on the left.



Match the colors shown in the picture on the left.



Match the colors shown in the picture on the left.



Match the colors shown in the picture on the left.

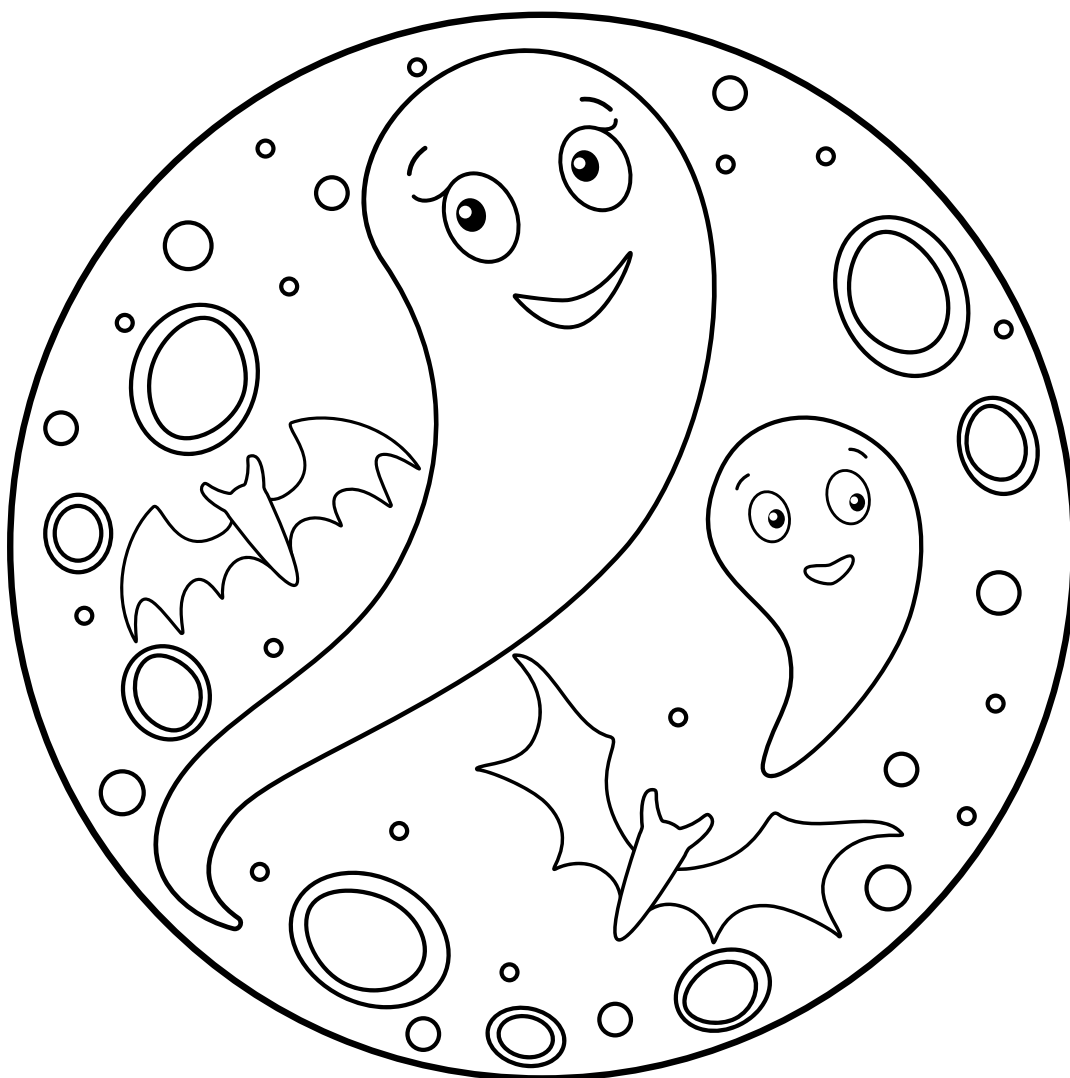

Match the colors shown in the picture on the left.

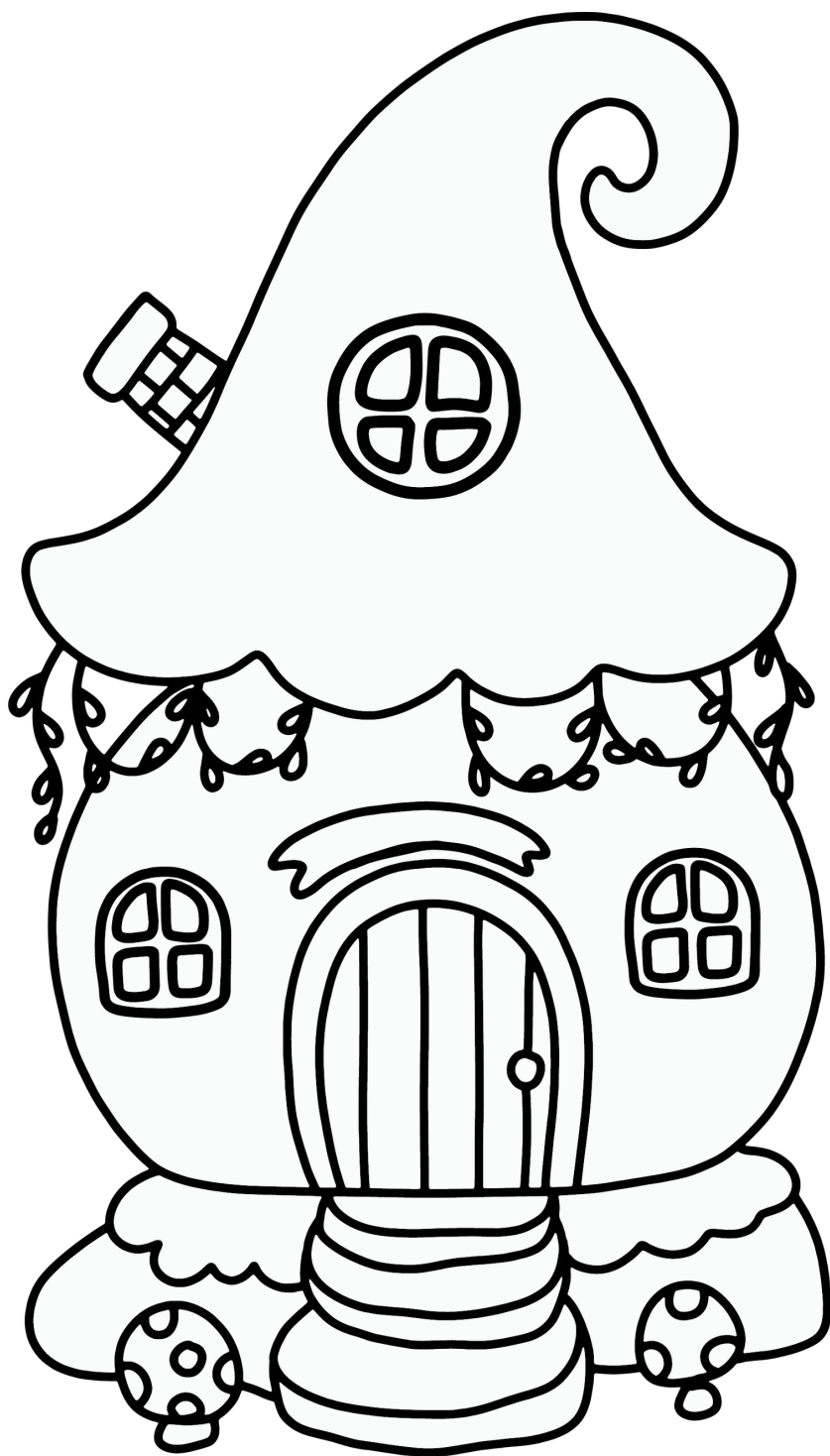
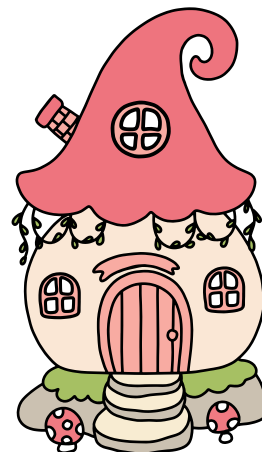

Match the colors shown in the picture on the left.

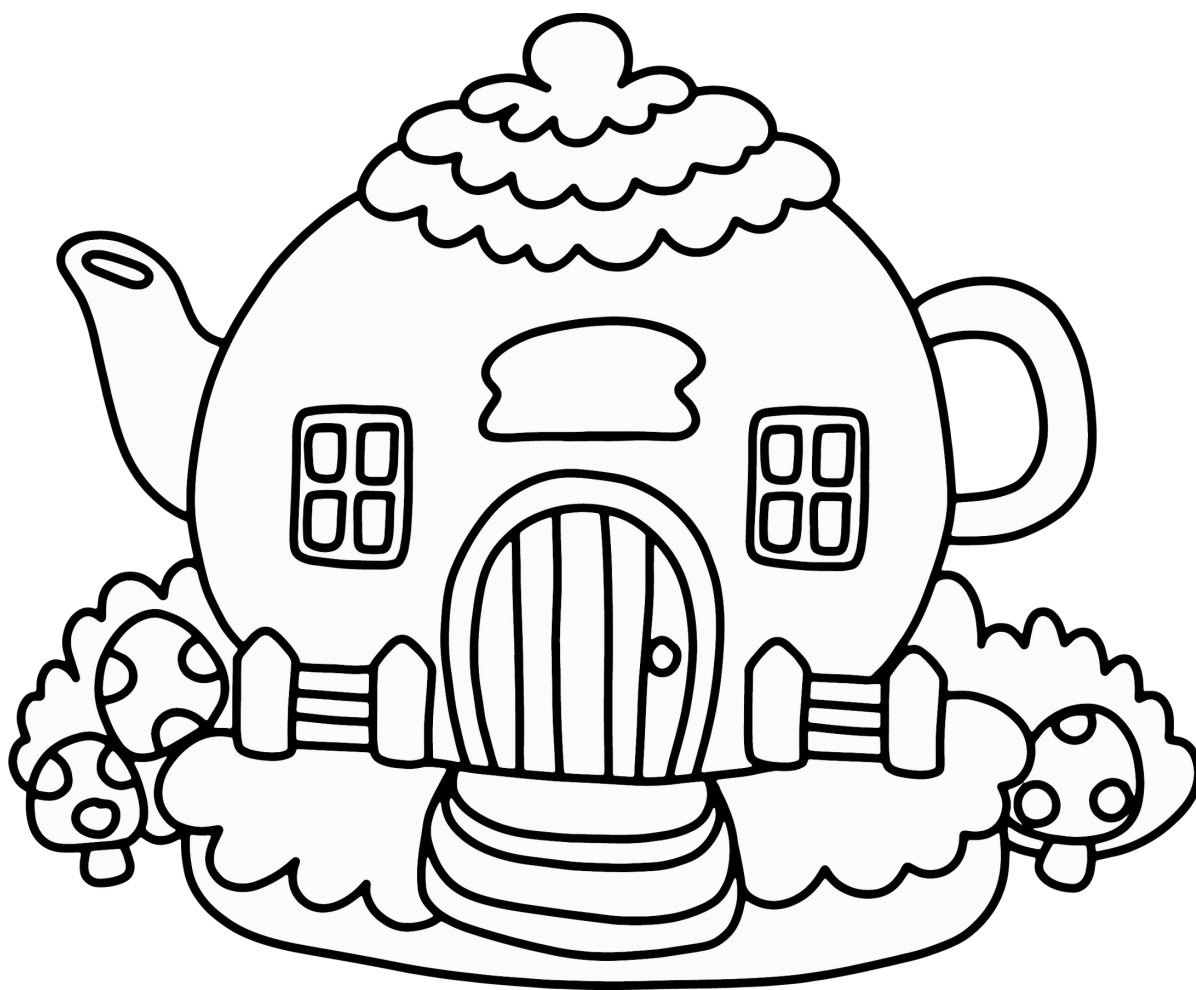

Match the colors shown in the picture on the left.



Match the colors shown in the picture on the left.

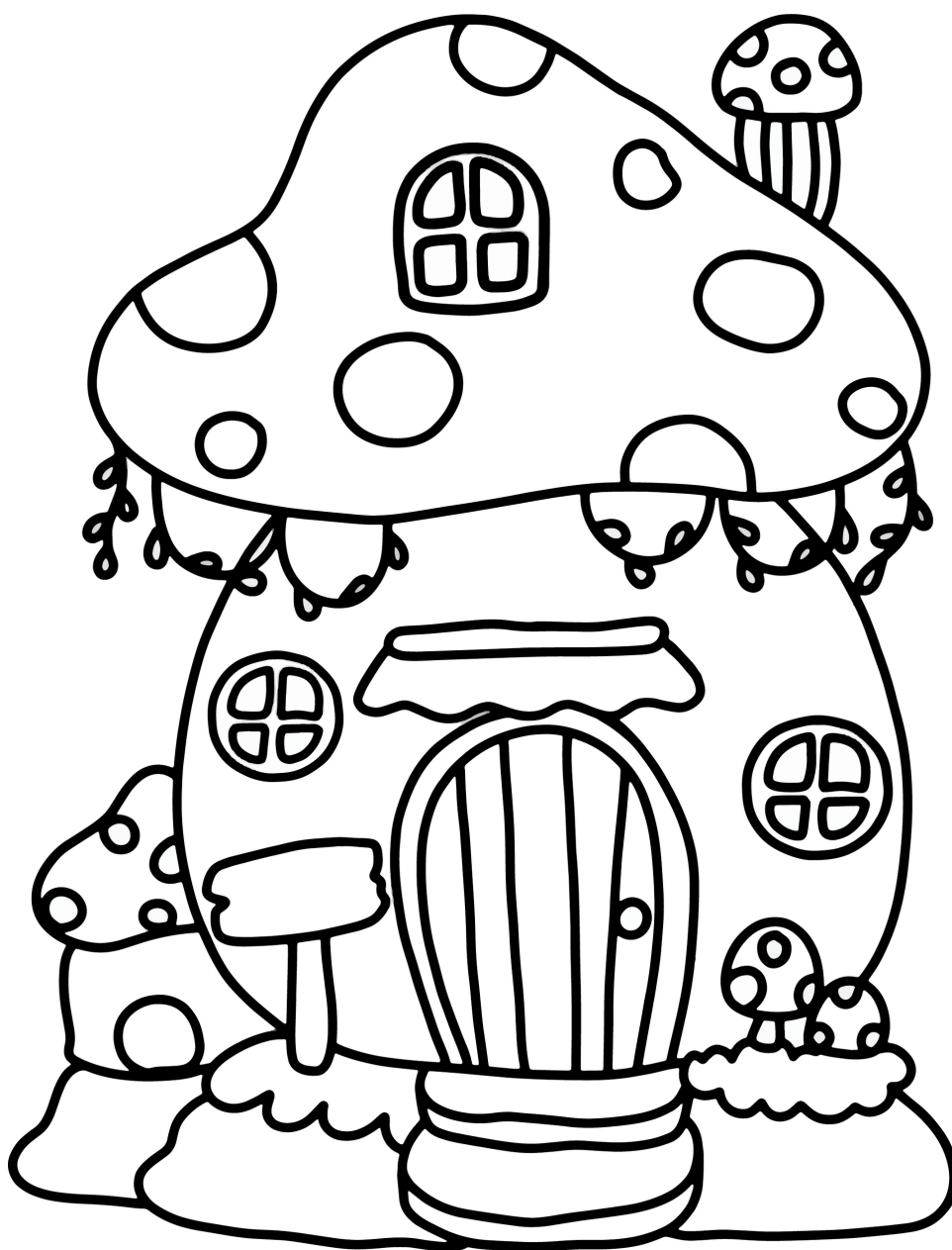

Match the colors shown in the picture on the left.



Match the colors shown in the picture on the left.



Color by Number Garden

Use the key at the bottom of the page to color the picture.

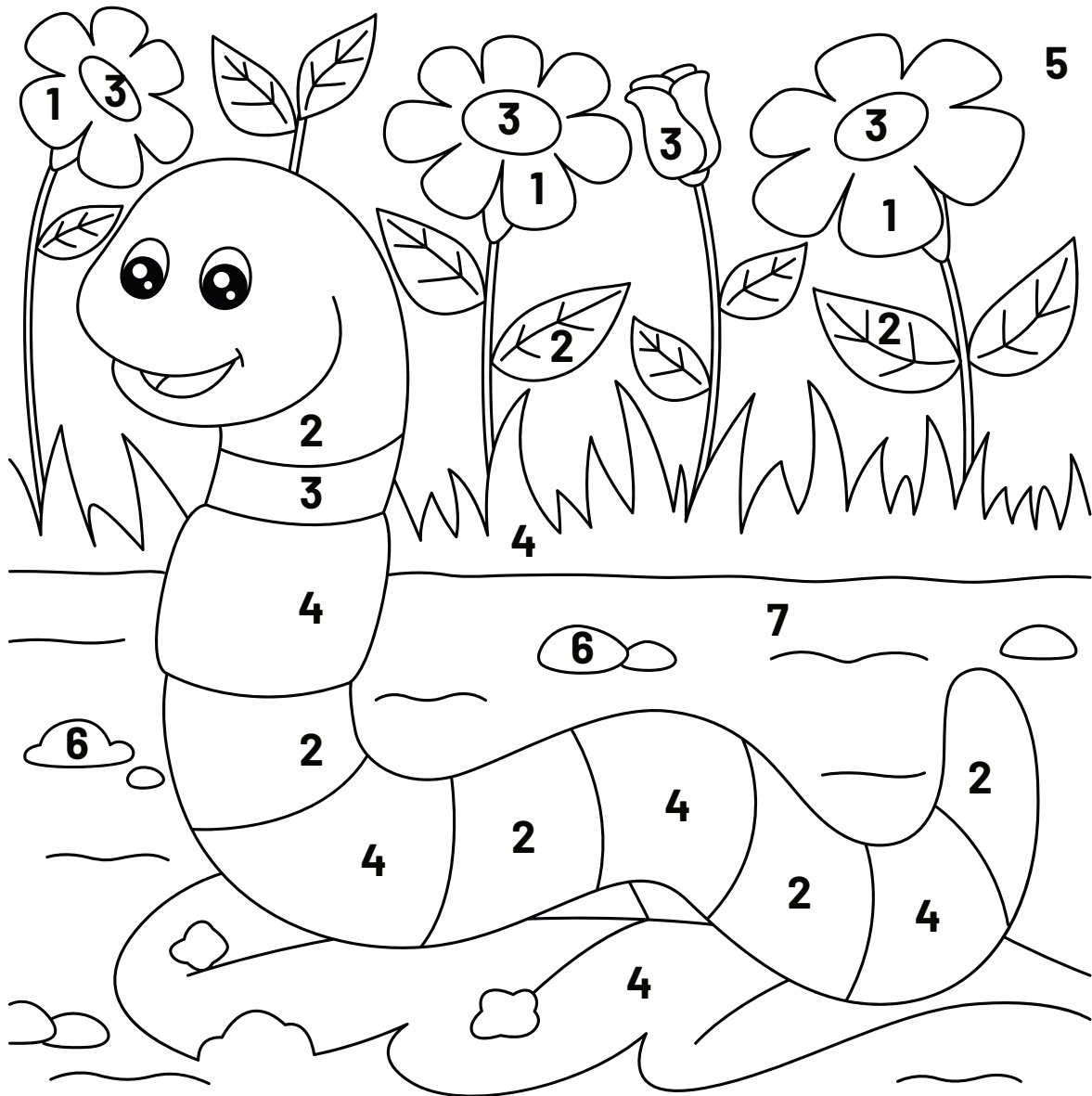

Color by Addition

Use the key at the bottom of the page to color the picture.

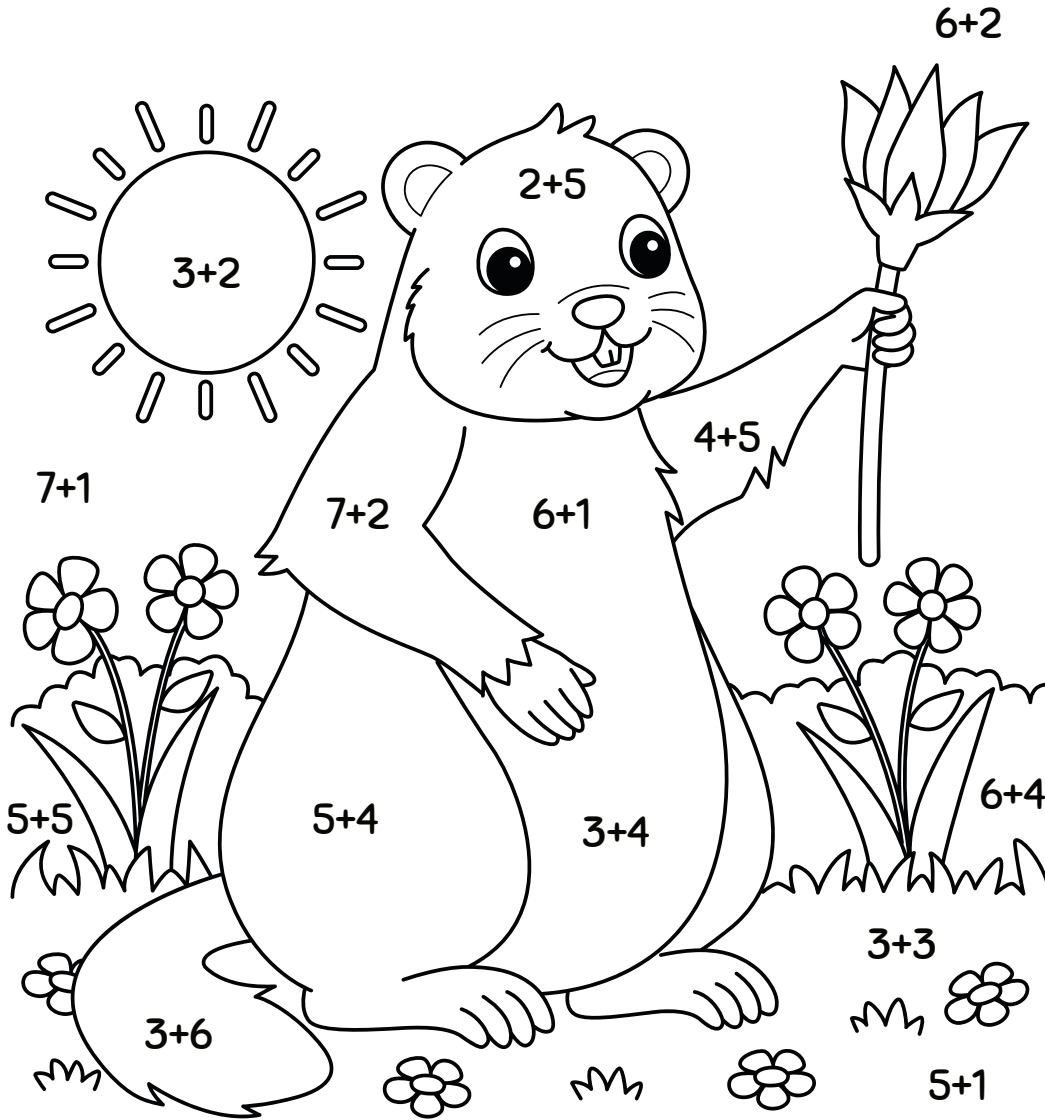

Color by Addition

Use the key at the bottom of the page to color the picture.

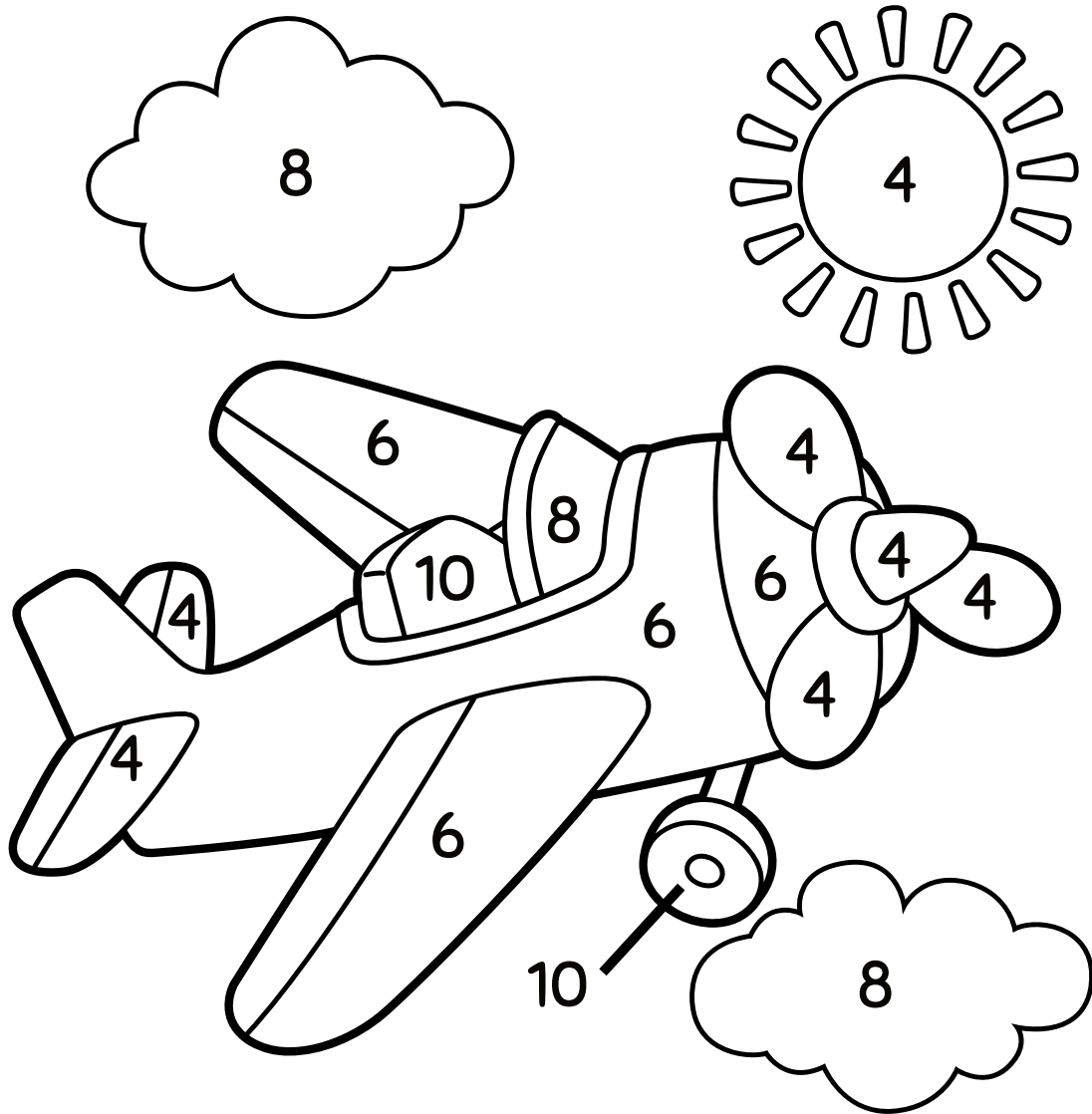

$7+3$



$4+2$



$6+2$



$3+1$



Chinese New Year: Rabbit

Color by Number

Use the key at the bottom of the page to color the picture.

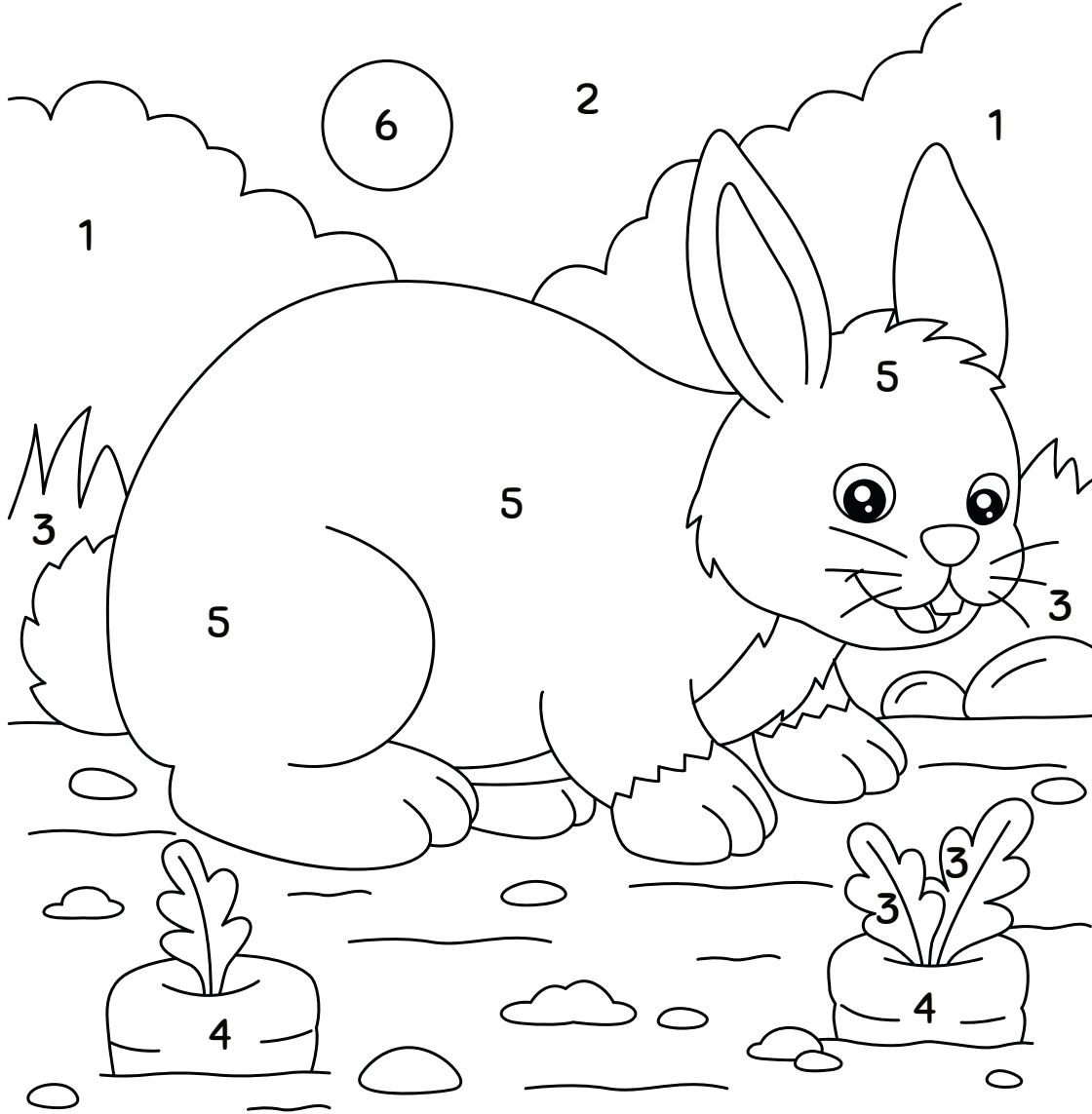

Mermaid Coloring



Mermaid Coloring



Mermaid Coloring



Mermaid Coloring



Mermaid Coloring



Mermaid Coloring



Mermaid Coloring



Mermaid Coloring



Mermaid Coloring



